

GangPro-CC

Flash Gang Programmer for the CC series devices

User's Manual

Software version 2.10

*PM025A01 Rev.6
October-06-2012*

Elprotronic Inc.

16 Crossroads Drive
Richmond Hill,
Ontario, L4E-5C9
CANADA

Web site: www.elprotronic.com
E-mail: info@elprotronic.com
Fax: 905-780-2414
Voice: 905-780-5789

Copyright © Elprotronic Inc. All rights reserved.

Disclaimer:

No part of this document may be reproduced without the prior written consent of Elprotronic Inc. The information in this document is subject to change without notice and does not represent a commitment on any part of Elprotronic Inc. While the information contained herein is assumed to be accurate, Elprotronic Inc. assumes no responsibility for any errors or omissions.

In no event shall Elprotronic Inc, its employees or authors of this document be liable for special, direct, indirect, or consequential damage, losses, costs, charges, claims, demands, claims for lost profits, fees, or expenses of any nature or kind.

The software described in this document is furnished under a licence and may only be used or copied in accordance with the terms of such a licence.

Disclaimer of warranties: You agree that Elprotronic Inc. has made no express warranties to You regarding the software, hardware, firmware and related documentation. The software, hardware, firmware and related documentation being provided to You “AS IS” without warranty or support of any kind. Elprotronic Inc. disclaims all warranties with regard to the software, express or implied, including, without limitation, any implied warranties of fitness for a particular purpose, merchantability, merchantable quality or noninfringement of third-party rights.

Limit of liability: In no event will Elprotronic Inc. be liable to you for any loss of use, interruption of business, or any direct, indirect, special incidental or consequential damages of any kind (including lost profits) regardless of the form of action whether in contract, tort (including negligence), strict product liability or otherwise, even if Elprotronic Inc. has been advised of the possibility of such damages.

END USER LICENSE AGREEMENT

PLEASE READ THIS DOCUMENT CAREFULLY BEFORE USING THE SOFTWARE AND THE ASSOCIATED HARDWARE. ELPROTRONIC INC. AND/OR ITS SUBSIDIARIES (“ELPROTRONIC”) IS WILLING TO LICENSE THE SOFTWARE TO YOU AS AN INDIVIDUAL, THE COMPANY, OR LEGAL ENTITY THAT WILL BE USING THE SOFTWARE (REFERENCED BELOW AS “YOU” OR “YOUR”) ONLY ON THE CONDITION THAT YOU AGREE TO ALL TERMS OF THIS LICENSE AGREEMENT. THIS IS A LEGAL AND ENFORCABLE CONTRACT BETWEEN YOU AND ELPROTRONIC. BY OPENING THIS PACKAGE, BREAKING THE SEAL, CLICKING “I AGREE” BUTTON OR OTHERWISE INDICATING ASSENT ELECTRONICALLY, OR LOADING THE SOFTWARE YOU AGREE TO THE TERMS AND CONDITIONS OF THIS AGREEMENT. IF YOU DO NOT AGREE TO THESE TERMS AND CONDITIONS, CLICK ON THE “I DO NOT AGREE” BUTTON OR OTHERWISE INDICATE REFUSAL, MAKE NO FURTHER USE OF THE FULL PRODUCT AND RETURN IT WITH THE PROOF OF PURCHASE TO THE DEALER FROM WHOM IT WAS ACQUIRED WITHIN THIRTY (30) DAYS OF PURCHASE AND YOUR MONEY WILL BE REFUNDED.

1. License.

The software, firmware and related documentation (collectively the “Product”) is the property of Elprotronic or its licensors and is protected by copyright law. While Elprotronic continues to own the Product, You will have certain rights to use the Product after Your acceptance of this license. This license governs any releases, revisions, or enhancements to the Product that Elprotronic may furnish to You. Your rights and obligations with respect to the use of this Product are as follows:

YOU MAY:

- A. use this Product on many computers;
- B. make one copy of the software for archival purposes, or copy the software onto the hard disk of Your computer and retain the original for archival purposes;
- C. use the software on a network

YOU MAY NOT:

- A. sublicense, reverse engineer, decompile, disassemble, modify, translate, make any attempt to discover the Source Code of the Product; or create derivative works from the Product;
- B. redistribute, in whole or in part, any part of the software component of this Product;

C. use this software with a programming adapter (hardware) that is not a product of Elprotronic Inc.

2. Copyright

All rights, title, and copyrights in and to the Product and any copies of the Product are owned by Elprotronic. The Product is protected by copyright laws and international treaty provisions. Therefore, you must treat the Product like any other copyrighted material.

3. Limitation of liability.

In no event shall Elprotronic be liable to you for any loss of use, interruption of business, or any direct, indirect, special, incidental or consequential damages of any kind (including lost profits) regardless of the form of action whether in contract, tort (including negligence), strict product liability or otherwise, even if Elprotronic has been advised of the possibility of such damages.

4. DISCLAIMER OF WARRANTIES.

You agree that Elprotronic has made no express warranties to You regarding the software, hardware, firmware and related documentation. The software, hardware, firmware and related documentation being provided to You “AS IS” without warranty or support of any kind. Elprotronic disclaims all warranties with regard to the software and hardware, express or implied, including, without limitation, any implied warranties of fitness for a particular purpose, merchantability, merchantable quality or noninfringement of third-party rights.



This device complies with Part 15 of the FCC Rules. Operation is subject to the following two conditions:

- (1) this device may not cause harmful interference and*
- (2) this device must accept any interference received, including interference that may cause undesired operation.*

NOTE: *This equipment has been tested and found to comply with the limits for a Class B digital devices, pursuant to Part 15 of the FCC Rules. These limits are designed to provide reasonable protection against harmful interference in a residential installation. This equipment generates, uses, and can radiate radio frequency energy and, if not installed and used in accordance with the instruction manual, may cause harmful interference to radio communications. However, there is no guarantee that interference will not occur in a particular installation. If this equipment does cause harmful interference to radio or television reception, which can be determined by turning the equipment off and on, the user is encouraged to try to correct the interference by one of more of the following measures:*

- * Reorient or relocate the receiving antenna*
- * Increase the separation between the equipment and receiver*
- * Connect the equipment into an outlet on a circuit different from that to which the receiver is connected*
- * Consult the dealer or an experienced radio/TV technician for help.*

Warning: *Changes or modifications not expressly approved by Elprotronic Inc. could void the user's authority to operate the equipment.*



This Class B digital apparatus meets all requirements of the Canadian Interference-Causing Equipment Regulations.

Cet appareil numérique de la classe B respecte toutes les exigences du Règlement sur le matériel brouilleur du Canada.

Table of Contents

1. Introduction	9
2. Features	10
2.1 Key features	10
2.2 Custom features	11
2.2.1 Encrypted Project option	11
2.2.2 Script file	11
2.2.3 DLLs	11
3. Getting Started	13
3.1 Software Installation	13
3.1.1 Driver Installation	13
3.2 Hardware Setup	14
3.3 Starting up "GangPro-CC" Flash Programmer	16
3.4 X-Pro Selector	16
4. Programming Dialogue Screen	18
4.1 SoC Device Type	19
4.2 Code File Management	20
4.3 Flash Protection Bits	23
4.4 Power Device from Adapter	23
4.5 Target Device selector and action result	25
4.6 Device Action box	26
4.6.1 Auto Program button	27
4.6.2 Verify LOCK bits	27
4.6.3 Erase Flash button	28
4.6.4 Blank Check button	28
4.6.5 Write Flash button	29
4.6.6 Verify Flash button	29
4.6.7 Read/ Copy Flash button	30
4.7 Next button	31
5. Data viewers	32

6. <i>Memory Option Dialogue Screen</i>	35
6.1 Memory Erase/Write/Verify Group	36
6.2 Read Group	37
6.3 Verification Group	38
7. <i>Adapter Options</i>	39
7.1 Communication Dialogue Box	39
7.1.1 Communication Speed	39
7.2 Reset Dialogue Box	39
7.2.1 Reset pulse duration	40
7.2.2 Final Target Device action	40
7.3 Options Dialogue Box	41
8. <i>Serialization</i>	42
8.1 Introduction	42
8.2 IEEE Address & Serialization Dialogue Screen	44
8.2.1 IEEE Address selection	45
8.2.2 IEEE/SN Record File	47
8.2.3 Serial number formats	48
8.2.4 Model, Group, Revision	56
8.2.5 Device Serialization box	57
8.3 Serialization Report Dialogue Screen	59
9. <i>IEEE /SN data file</i>	61
10. <i>Check Sum Options</i>	66
10.1 Check Sum types	69
11. <i>Script File - defined programming sequence</i>	74
11.1 Script button	74
11.2 Script file option	75
11.3 Script commands	76
12. <i>Project and Configuration Load / Save</i>	82
12.1 Load / Save Setup	82
12.2 Load / Save Project	82
12.3 Commands combined with the executable file	86

<i>13. Target connection</i>	90
13.1 Connection via Debug Interface	90
13.2 Connection via SPI Interface	95
<i>14. Driver for the IAR C-Spy debugger</i>	97
<i>15. Driver for the Keil uVision debugger</i>	103
Appendix A - specification	106

1. Introduction

The **GangPro-CC** programmer is designed to allow simultaneous programming of up to six CC series SoC with 8051 MCU devices (Chipcon products from Texas Instruments). The programmer configures target devices by using the **debug** interface.

The programmer package consist of a microcontroller based adapter (Figure 1-1), Windows™ based software, a Gang Splitter to connect up to 6 devices to the adapter, and cable to connect the



Figure 1-1

adapter with the computer's USB port. The internal firmware software allows to communicate with the programmed device with high speed. The effective programming speed (write only) is around **20 kbytes/s** simultaneously up to six target devices that is equivalent to **120 kbytes/s** programming speed per one programmed target device. Due to this high speed communication, programming time is very short and programmer can be used to program flash devices in the production process. For example, six devices with **128 kB Flash**, such as CC2430F128, can be programmed in **12 seconds**. This time includes initialization, erasing memory, blank checking, programming and fast verification.

To simplify production process the programming software package can assign IEEE address, serial number, model type, and revision. Each IEEE address and serial number are unique for each programmed device and are assigned automatically. Several serial number formats are available.

There are a number of erase/write options available as well. This allows to erase/write all flash memory, or just the specified fragment of memory. This feature is very useful when only part of programmed data/code should be replaced. For example one can download the serial number, calibration data or personality data without erasing existing program code.

2. Features

The **GangPro-CC** programmer is dedicated to simultaneously program up to six CC series SoC with 8051 MCU Chipcon Product from Texas Instruments. To facilitate high speed communication, an application software for the programming adapter has been optimized for the maximum speed.

2.1 Key features

The key features of the *GangPro-CC* programmer are:

- * Support all CC Chipcon devices from Texas Instruments.
- * Programming speed via debug interface is approximately **20 kBytes/s** per target device. Up to six target devices can be programmed simultaneously, effectively programming at a rate of **120 kbytes/s**,
- * Our programmers are professionally made and are **recommended by Texas Instruments** as the Third Party Tools source.
- * Full memory or sector memory erase capability.
- * Write Check Sum verification.
- * No code size limitations.
- * Target device can be powered from the programming adapter or from external source.
- * Easy to use WindowsTM based software.
- * Programmer accept TI (*.txt), Motorola (*.s19) and Intel (*.hex) data files for programming.
- * Combine code files capability.
- * Lock setup capability, useful in production.
- * Software package can assign and automatically increment **IEEE address** and **serial number**, model type and revision. Serial Number with or without an automatically inserted current date can be stored in the FLASH memory in HEX, BCD or ASCII format. Log file capability allowing to review information about the flashed target devices.
- * **DLL** software package can control programmer from other programs.
- * Driver for the IAR CSpY - EW8051 for debugging using FPA and IAR Embedded Workbench IDE software.
- * Programmer has been fully tested to comply with the **FCC** and **CE** requirements.
- * Uses USB-1.1 (12Mbits/s) Port to communicate with the Programming Adapter.

2.2 *Custom features*

The *GangPro-CC* programmer can be controlled from an external software as well as custom scripts to specify programming sequences. These features are very useful in production environment.

2.2.1 *Encrypted Project option*

Contents of the project that include code contents downloaded to target device can be encrypted and blocked against unauthorised access.

2.2.2 *Script file*

A user can define a sequence of programming steps by the means of a script file. The script file is a sequence of programmer commands, where each command corresponds to a button in the programming software. Each command can be accompanied by a few options. A script file of up to 1000 lines can be created. The detailed description of script commands is given in Chapter 10. Please note that the script file is not available in the **lite** version of the programming software.

The second option allows to use command line interpreter (not available in the **lite** version), that can fully control the programming adapter via Multi-FPA API-DLL.

2.2.3 *DLLs*

The programming adapter can also be controlled through user created applications. For this purpose a DLL is provided to allow a user to develop custom application that can control the programming adapter and allow the programming of target devices via the *GangPro-CC* adapter. The Multi-FPA API-DLLs allows to fully control up to 16 programming adapters (to program simultaneously up to 96 target devices) from external software written in MS Visual C++, MS Visual Basic, LABView, DOS or other programming packages like Borland C++ etc. See the “*GangPro-CC FlashProgrammer - Remote Control Programming User’s Guide*” for details.

To speed up programming process it is recommended to program full panel with a lot of boards on the panel before de-panelization. Access from FPAs to all target devices can be done via nails (see Figure 2-1).

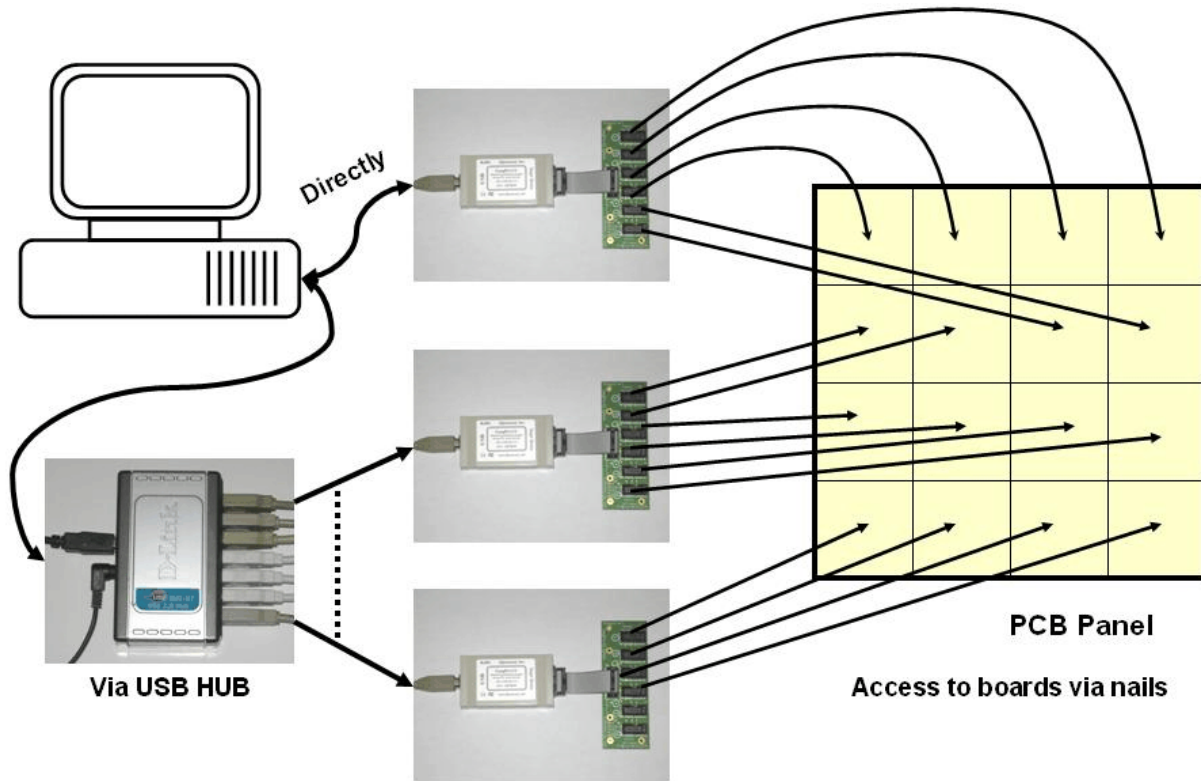

Figure 2-1

2.2.4 Driver for the IAR CSpy and KEIL uVision debugger

The FPA programming adapter can also be used with the IAR Embedded Workbench or KEIL uVision IDE software for debugging. See chapters 12 and 13 for details.

3. Getting Started

GangPro-CC programmer package contains:

1. One READ ME FIRST document.
2. One **X-Pro-CC** - Flash Programmer CD ROM (Software + Manual).
3. One **GangPro-CC** Flash Programming Adapter.
4. One 6 feet length USB-A to USB-B cable.
5. GangPro-CC Splitter that allows to connect six target devices to one USB-FPA adapter.
6. Six ribbon cables - with 10 pins connectors.
7. One 14-pins ribbon cable.

3.1 Software Installation

The **X-Pro-CC** Flash Programming Software runs on PC under Windows™ ME, WinNT, 2000, XP, Vista (32 or 64-b) or Win-7 (32 or 64-b). Follow instructions below to install the software:

1. Insert **X-Pro-CC** Software CD into your CD-ROM drive.
2. The **X-Pro-CC** Setup wizard appears automatically. Click *Install X-Pro-CC Programmer* to begin the installation process.
3. If the Setup wizard does not start automatically, click the Start button and choose the Run dialogue box. Type “D:\SETUP.EXE”, where D represents the drive letter of your CD-ROM drive. Then click the OK button.
4. Once the installation program starts, on-screen instructions will guide you through the remainder of the installation. You **must** accept licence agreement before using software.

3.1.1 Driver Installation

Software installation program is placing the USB driver files in the windows directories

Windows\inf

and

Windows\system32\drivers

that simplified driver installation. When the software package mentioned above starts, the following screen will pop-up (see figure 3.1-1).

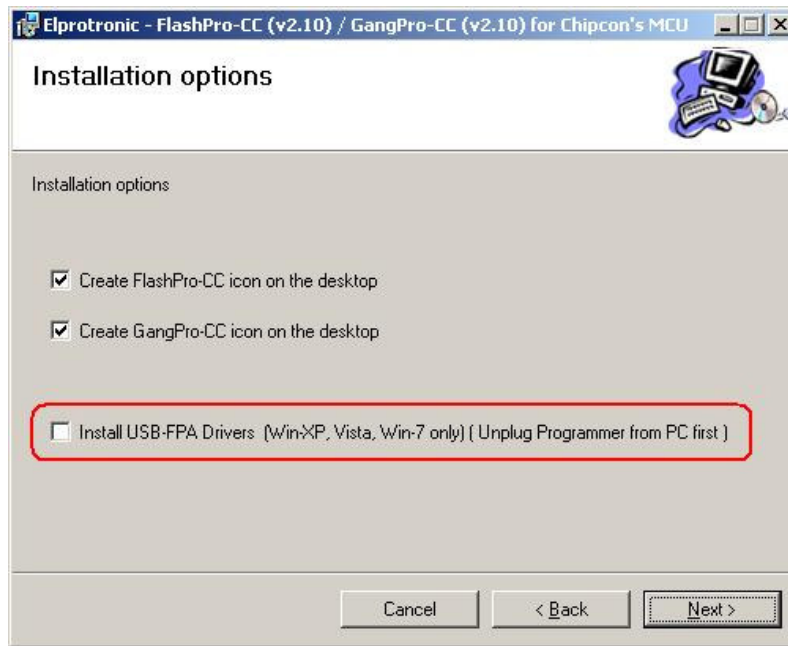

Figure 3.1-1

Select - InstallUSB-FPA Driver..... option if the driver was not installed before. When the installation software is finished, then the USB driver is preinstalled. Driver preinstallation can also be executed by running the *USB-FPA-DriverInstaller.exe* software located in directory

C:\Program Files\Elprotronic\Drivers USB-FPA\XP,Vista,Win-7

When the driver preinstallation is done then plug-in USB-FPA adapter to USB- PC port. The driver installation should be done automatically in Win-7 64, and in the Win 32 OS (XP, Vista, Win7 32b) the wizard should start. Follow instruction in wizard by pressing “*recommended*” option buttons and all should be done.

See *USB-FPA Driver Installation.pdf* document located in

C:\Program Files\Elprotronic\Drivers USB-FPA\directory if you find any problems.

3.2 *Hardware Setup*

1. Connect the USB-FPA Flash Programming Adapter to the PC USB Port or via USB-HUB using provided cable extender (USB-A to USB-B) (see figure 3.2-1).
2. Plug in socket connector from the USB-FPA Flash Programming Adapter to the J1 connector on the GangPro-CC Splitter (PN: PE014X03) using ribbon cable with 14-pins connectors. Connect up to six target devices to GangPro-CC Splitter using ribbon cables with 10-pins

connectors. Make sure that pin 1 on your device board's header is connected to pin 1 (red wire) of the socket connector.

- Target devices can be supplied from programming adapter (programmable Vcc = 2.2V to 3.6V with step 0.2V, max total current 100 mA)(see Figure 3-2.2-top) or from external power supply. When target devices are supplied from external power supply then power supply ON/OFF can be controlled from programming adapter (see Figure 3-2.2-bottom).

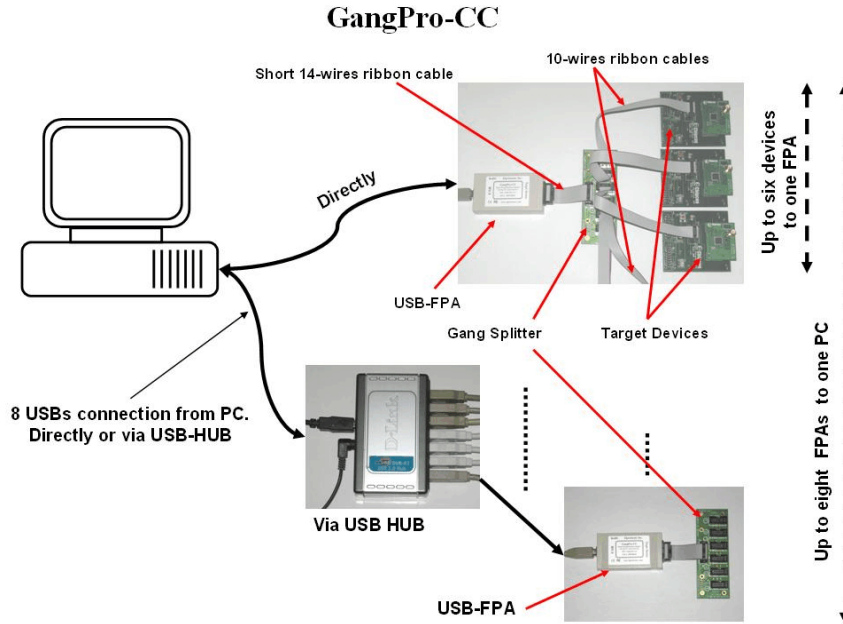

Figure 3.2-1

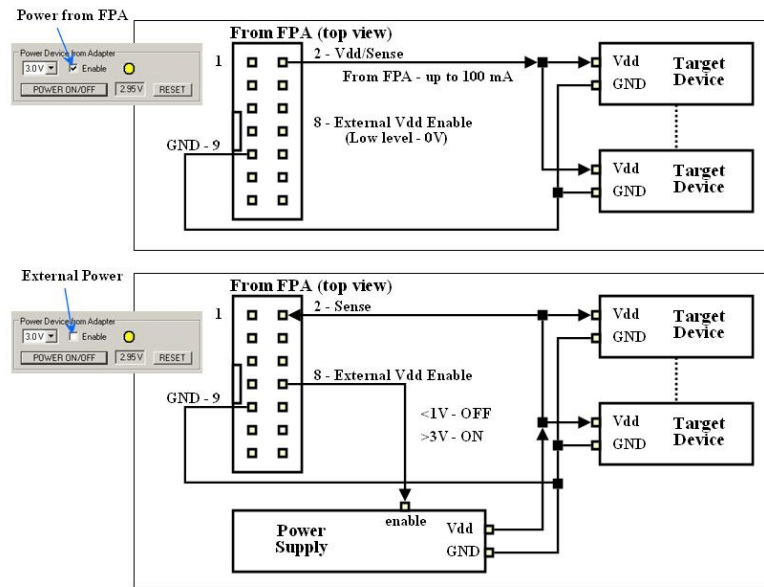

Figure 3-2.2

3.3 Starting up “GangPro-CC” Flash Programmer

To start the *GangPro-CC* Flash Programmer click on the GangPro-CC Elprotronic icon.



Figure 3.3-1

Once started the software will attempt to access the programming adapter. If no error messages appear then the software has initialized without a problem and you may begin using it. However, if the programming adapter is not detected an error message will appear. To correct the problem, make sure that the connection cable is properly attached and the USB driver is installed.

3.4 X-Pro Selector

The *X-Pro430* software has a Multi-USB feature. Up to 16 Flash Programming Adapters can be connected to one PC. Each adapter can be controlled by a separate instance of the programming software application. Up to 16 applications can be opened at the same time. Each application can have independent setup from the others (code file, controlled microcontroller type etc.).

When more than one *X-Pro FPA* Adapter is connected to a PC then each time you start the programmer application a *X-Pro FPA Selector* dialogue screen will appear (see Figure 3.4-1). The dialogue screen will list all adapters connected and allow you to choose the adapter you wish the application to control. Make a sure that the selected *FPA* is not used by another opened application. The selected *FPA*'s serial number will be displayed on the bottom left side of the programming dialogue screen.

When the Multi-FPA API-DLL is used, then all adapters can be controlled from one software. See the “*GangPro-CC FlashProgrammer - Remote Control Programming User’s Guide*” for details.

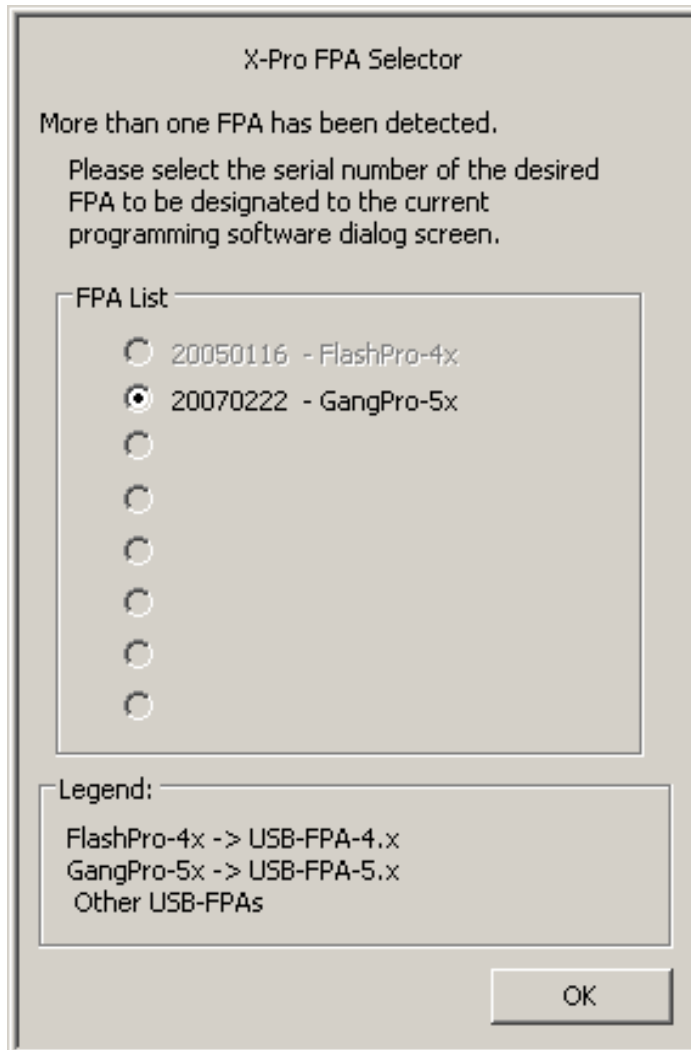

Figure 3.4-1

4. Programming Dialogue Screen

The programming dialogue box (see Fig. 4-1.) contains a pull down menu, interface selection box, lock protection bits box, device action buttons, report (status) window, open file buttons, target device information box, IEEE addresses and serial number box, power DC status and check sum result boxes.

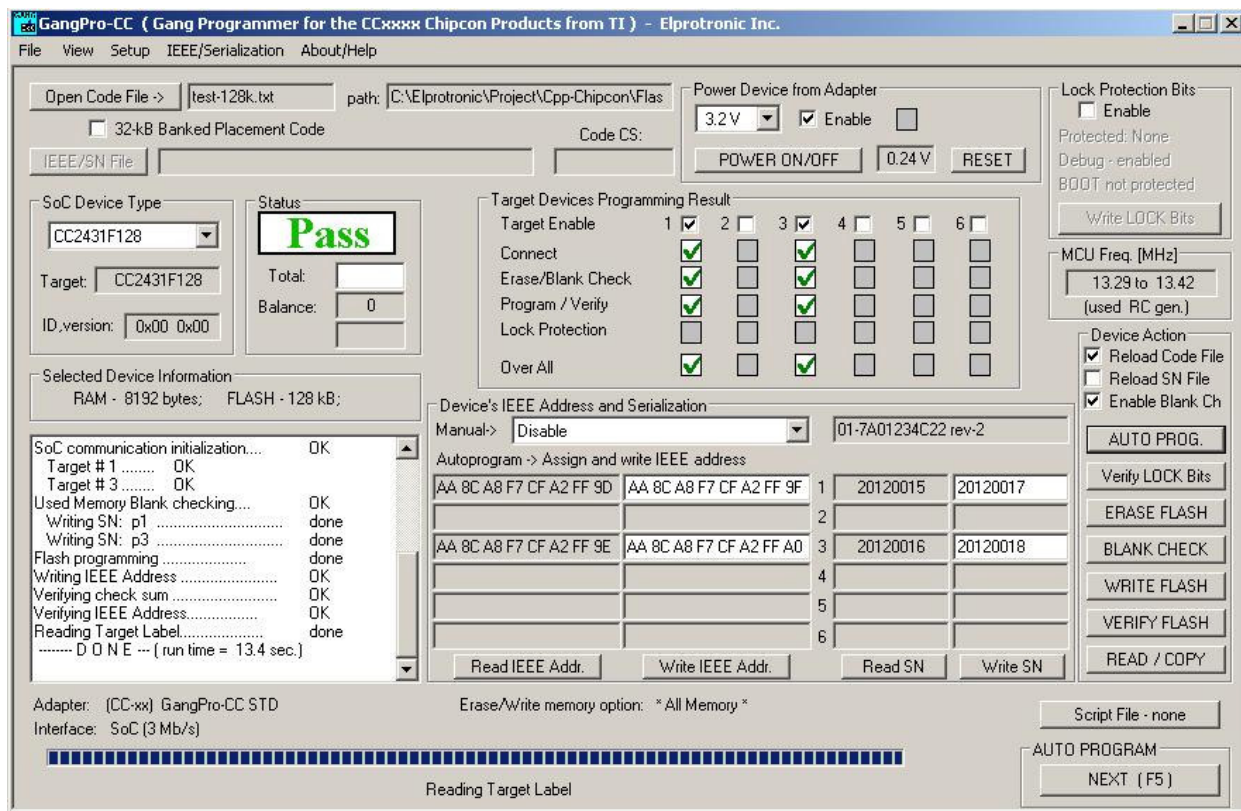









Figure 4-1. Programming dialogue box screen.

All device action buttons, power ON/OFF button and the check sum result box have their own status indicators. Each indicator can assume any of the following conditions:

-  - blank - idle status.
-  - yellow - Test in progress. For power on/off - DC voltage is correct.
-  - green - access enabled.
-  - red sign - access denied. For power on/off - DC voltage is too low (below 2.0V)
-  - device action has been finished successfully.
-  - device action has been finished, but result failed.
-  - applies to blank check only - Memory is not clean, but the specified memory segment is.

4.1 SoC Device Type

Target device type can be selected from the pull down field of the SoC Device type group. The pull down field contains a list of all devices in CC series family currently available. To automatically detect the microcontroller type choose the '- - -' option from the drop down list.

When communication between the microcontroller and the programming adapter is initialized, the software will detect the target microcontroller automatically. The type of detected microcontroller is displayed in the field '**Target:**'. This allows the software to warn you if the connected microcontroller does not match the one specified by the user.

Note: No warning message will appear when '- - -' microcontroller type is selected.

Note: If more than one target device is connected to GangPro-CC programmer then all target devices should be the same type. It is not possible to simultaneously program target devices of different type.

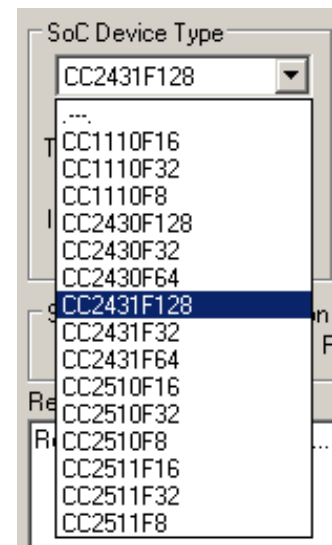

Figure 4.1-1

4.2 Code File Management

The *GangPro-CC* flash programmer provides a few options to manage code files. These options allow the user to open a code file, combine several code files into a single file, and save the programming data into a code file. The *Open Code File* button, or the *Open Code File* from the

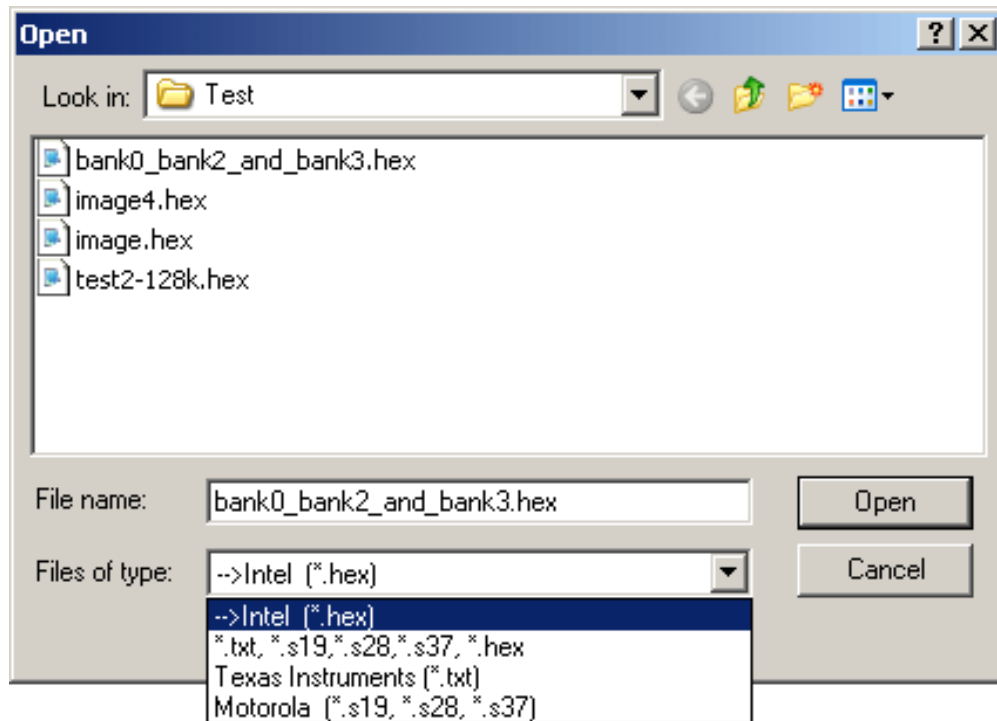

Figure 4.2-1

FILE pull down menu, prompts for opening the object file that contains the code data, as shown in Figure 4.2-1. When the file is selected the contents of the object file are downloaded into the PC memory. If the selected target device does not have enough memory to fit the data contained in the code file, the warning message in Figure 4.2-2 will be displayed.

When code file is opened and read successfully the code file name and full path will be displayed on the right side of the *Open Code File* button (see Fig.4-1 Programming dialogue box screen). Contents of the selected file can be viewed by the selecting of '*Code File Data*' from the '*View*' menu (see chapter 5).



Figure 4.2-2

The **Combine Code Files** option allows up to 40 code files to be loaded into the PC memory. When this option is selected the programmer will create a new data block, which will contain the combined data of the user selected files. In order to add a code file to the newly created data block, the user needs to press the **ADD Code File** button. The programmer will then prompt the user to specify the code file to be appended to the newly created memory block, using the window in Figure 4.2-1. Every appended file will be verified, so that the total code size does not exceed the target microcontroller's memory space and that there is no overlap with previously selected code segments. After the addition of each file the window in Figure 4.2-3 will be shown. The window shows the status of previous append operations.

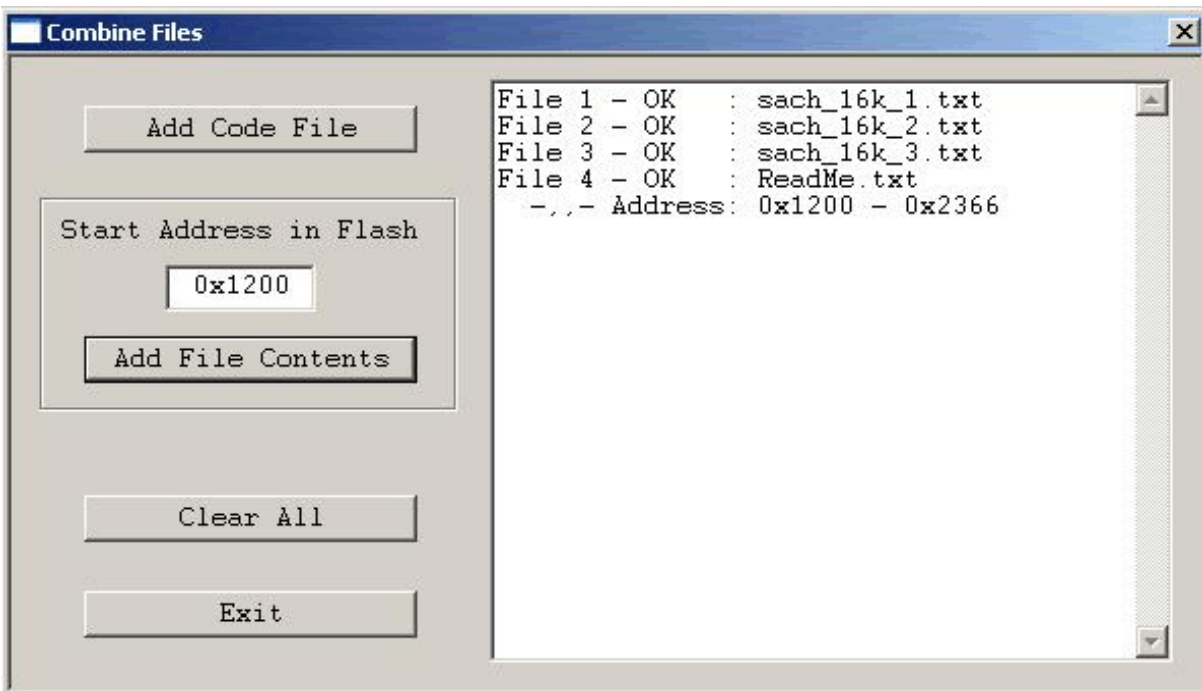

Figure 4.2-3

The Programmer is also able to append files of any type to the new data block. In order to do this the user must specify the memory location into which the programmer is to load the file and then press the **Add file contents** button. The window in Figure 4.2-1 will appear prompting the user to specify the file to be added. Once the file is added to the new memory block, the programmer will display the memory space occupied by the selected file. An example of this is shown in Figure 4.3-3 for the file number 4.

The **Save Code File** option saves the data currently contained within the PC code data block into a code file. When the user selects this option from the File menu, the window in Figure 4.2-4 will appear, prompting for the name of the file to be created.

All of the aforementioned Code File options work with three most popular code file formats. These formats are the Texas Instruments, the Motorola and the Intel file formats. **GangPro-CC** will work with any of these formats and will easily convert one file format to another by using the Open Code File and Save Code File options.

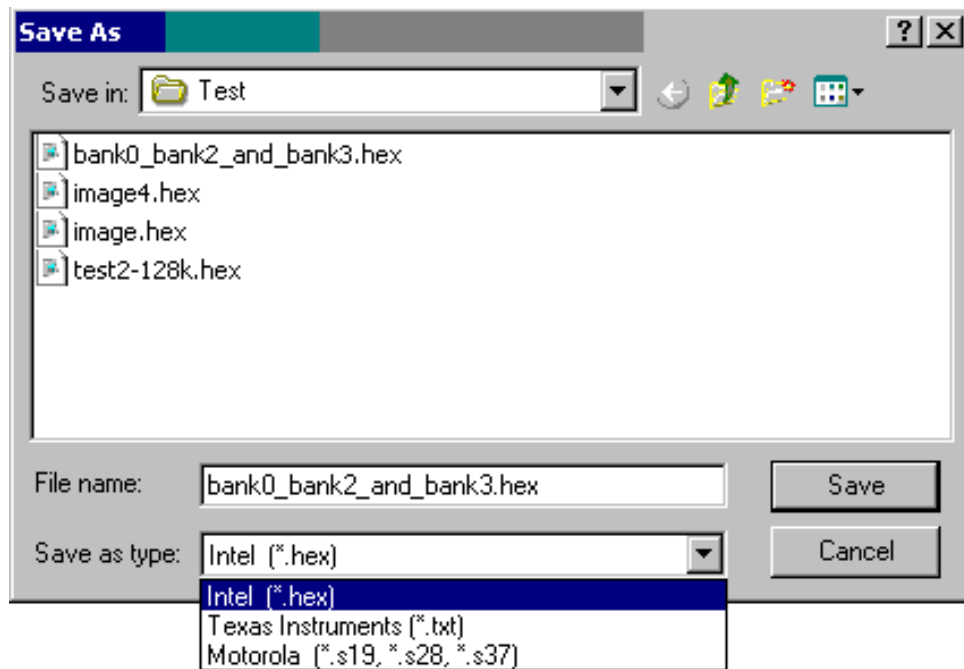

Figure 4.2-4

4.3 Flash Protection Bits

The CC series devices memory can be protected against unauthorized access or can protect a whole or part of flash against erase or write to the protected flash space. The GangPro-CC software allows the user to program the protection bits. In the right top corner of the main dialogue screen the selected option of the protection bits (Figure 4.3-1) is displayed. When the **Enable** option is selected, then all protection bits will set in the CC device. Desired combination of the protection bits can be selected in the **Memory Option** setup dialogue available from pull down menu “**Setup->Memory Option**”. See chapter 6 for details.

To program the protection bits the check mark ‘**Enable**’ in the ‘**Lock Protection Bits**’ group must be selected first (see Figure 4.3-1).

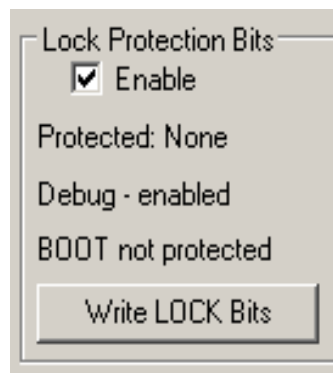

Figure 4.3-1

4.4 Power Device from Adapter

The programming adapter is powered from the USB Port interface. Target device can be powered from the programming adapter with voltage range from 2.2V to 3.6V in step 0.2V selected in the voltage selector located in the ‘**Power Device from Adapter**’ box.

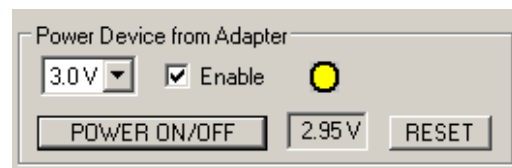

Figure 4.4-1

The target device will be powered from the adapter, if check box ‘**Enable**’ in the ‘**Power Device from Adapter**’ group (figure 4.4-1) is selected. When the ‘**Enable**’ checkbox is selected a warning message shown in figure 4.4-2 will be displayed. If you confirm this selection by clicking **YES**, then POWER ON/OFF button is enabled. By clicking POWER ON/OFF button you can turn the power on or off on the target device. Current DC voltage on the target device is continuously

monitored and displayed in the **'Device Voltage'** field in the **'Power Device from Adapter'** group, even if the target device is powered from the external DC sources. If DC voltage is higher than 2.0 V, then yellow box will be displayed, indicating that DC voltage is OK and target device is fully functional under this DC voltage. If DC level is below 2.0V, then access denied sign box will be displayed (red sign with white line). If DC level is below 1V, then blank sign box will be displayed.

When the target device is powered from the external power supply then the check box **'Enable'**

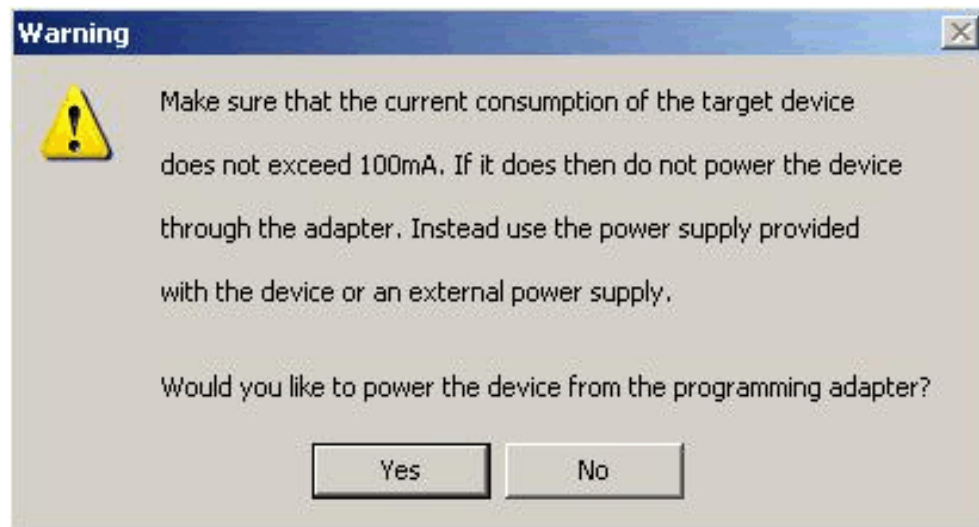

Figure 4.4-2

should not be selected. External power supply ON/OFF can be controlled from programming adapter (from pin-8) (see Figure 3-2.2-bottom). Voltage level on the pin-8 is over 3 V (typical 4.6V) when external power supply should be enabled, and below 1 V (typical 0V) when the external power supply should be OFF. It is recommended to put pull-down resistor on the enable input of the external power supply.







RESET button located on the right side on the POWER ON/OFF button (Figure 4.1) can generate a reset pulse to the target device. Pressing this button the target devices can be reset manually at any time, starting the target's device application program from the beginning.

4.5 Target Device selector and action result

In the Target Devices Programming Result group box is possible to select target devices to be activated - tested, programmed etc. Minimum one target device should be selected. All target devices connected to programming adapter should be the same type. Otherwise unpredicted state can be created.

When action with programmer is started then access to all targets are verified. Each part of process result is displayed in the test result icons (see figure 4.5-1).

All process result have their own status indicators. Each indicator can assume any of the following conditions:

-  - blank - idle status.
-  - yellow - test in progress..
-  - green - access enabled.
-  - red sign - access denied.
-  - device action has been finished successfully.
-  - device action has been finished, but result failed.
-  - applies to blank check only - memory is not clean, but the specified memory segment is.

Target Devices Programming Result						
Target Enable	1	2	3	4	5	6
Connect						
Erase/Blank Check						
Program / Verify						
Lock Protection						
Over All						

Figure 4.5-1

4.6 Device Action box

The Device Action box contains 7 buttons (see Figure 4.6-1). Each button allows a specific action to be executed. Software procedures related to each action allow you to fully execute the desired task, without the need to follow a specific sequence of actions. Every action starts by powering up the target device, if **Power Device from the Adapter** is enabled. When the DC voltage level becomes higher than 2.0V, the communication with the target device is initiated via the debug interface. The protection access bit is verified, if the access to the target device is available. Once the specified action is completed successfully the green check marks will appear (see Figure 4.5-1). Also, the device will return to the state it was in before the action was executed.

Progress of all actions is displayed in the report window. If the particular action has been finished successfully, then message 'done' or 'OK' will appear on the right side of processed procedure (Fig.4.6-2). If not, a message 'failed' will be displayed and selected action will be terminated. Final status is also displayed in the **Status** window (see Fig.4.6-3) as Active (blue), Pass (green), or Fail (red). On the bottom of the programmer dialogue screen the progress bar is displayed and the total run time is shown in the report window. Run time does not include the time when user interaction is required.

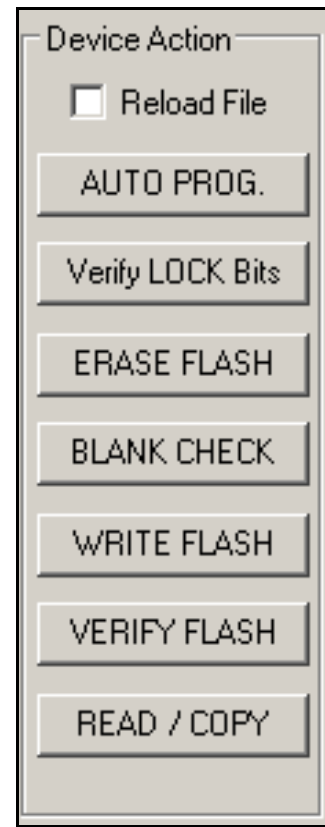

Figure 4.6-1

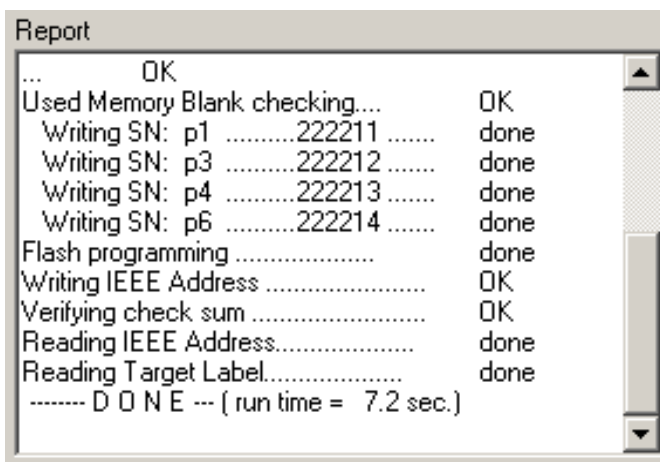

Figure 4.6-2

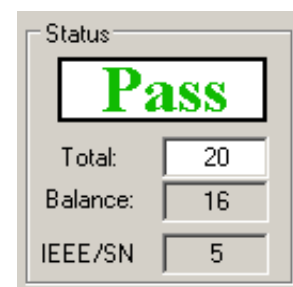

Figure 4.6-3

4.6.1 Auto Program button

The Auto Program button is the most frequently used button when programming target microcontroller devices in a production process. Auto Program button activates all required procedures to fully program and verify the flash memory contents. Typically, when the flash memory needs to be erased, *Auto Program* executes the following procedures:

- reload code file when “**Reload Code File**” is selected (useful for debugging when the code file is frequently modified)
- initialization
- read retain data from the flash if specified (optional).
- read label information (IEEE address, Serial Number, Model, Group, Revision)(optional)
- erase flash memory,
- erased memory blank check,
- flash programming and verification,
- assign or retrieve label information,
- restore retain data if specified,
- retain data verification if specified,
- assigned or retrieved label verification,
- flash memory check sum verification,
- set flash protection bits (if enabled).

In the report window you can see a typical report message during the Auto Program procedure (see Fig. 4.6-2).

Status window (see fig. 4.6-3) has a counter that is useful in a production process. The total number of programmed devices can be entered in the **Total** edit line. The **Balance** line shows the number of devices that have not been programmed yet. The Balance counter is initialized to the value entered in the **Total** edit line and is decremented every time *Auto Program* is completed successfully. In the bottom box in the *Status* group is displayed number of the available IEEE addresses and serial numbers taken from the used defined file.

Note: Balance counter works only with the Auto Program procedure.

4.6.2 Verify LOCK bits

This button allows the check the access to target device and read protection bits setup, if access is available.

4.6.3 Erase Flash button

This button enables the flash memory segments, or mass (all) memory to be erased. If any option other than '*Erase All Memory*' is selected in the Memory Options Setup (see chapter 6.1 *Memory Erase/Write/Verify Group* for details), then the following question message box will be displayed:

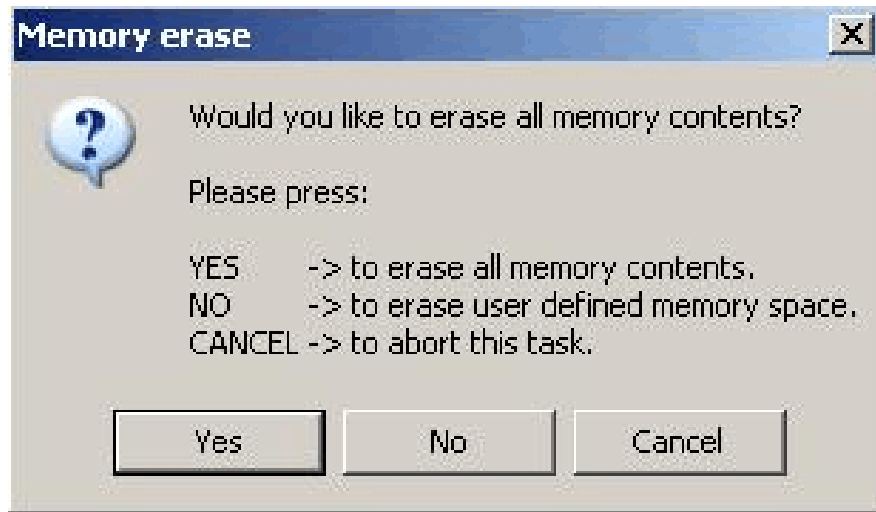





Figure 4.6.3-1

4.6.4 Blank Check button

When *Blank Check* button is clicked, the program checks if flash memory of the target microcontroller is blank (all bytes contain the value 0xFF). This test performs two checks. The first one determines if the entire memory contents is clean, while the second only checks a memory segment specified by the user (see setup in *Memory Erase/Write Group*). The following conditions can appear at the completion of this operation:

-  - all memory is blank
-  - all memory is not blank, but selected part of it is.
-  - memory is not blank.

4.6.5 Write Flash button

When write flash button is clicked, then contents from the code file will be written to the flash memory. When the second time target device is programmed, then the following warning message is displayed:



Figure 4.6.5-1

Note: See chapter 5.1 **Memory Erase/Write Group** for details on how to specify memory segment for writing.

4.6.6 Verify Flash button

The Verify Flash function compares the contents of the flash memory with data from the code file. Verify flash function can use the standard memory verification method (byte by byte) or calculate only the check sum of the code and check sum of the content in the flash (see *chapter 5. Memory Option Dialogue Screen*).

Note: During the verification process either all memory or just the selected part of the memory is verified, depending on settings specified in the Memory Erase/Write Address Range in the Memory Options setup. See chapter 5.1 **Memory Erase/Write Group** for details.

4.6.7 Read/ Copy Flash button

When 'Read/Copy' button is clicked then data can be read from the target microcontroller and displayed in the Flash Memory Data window (see Fig.4.6.7-1). This window can also be opened by selecting the 'Flash Memory Data' option from the 'View' menu. Flash memory data viewer, shown in figure 4.6.7-1, displays the code address on the left side, data in hex format in the central column, the same data in Ascii format in the right column. The contents of the code viewer can be converted to Texas Instruments *.txt file format by clicking on the 'Convert to TI format' button. Data will be viewed in the Notepad Editor.

The address range to be displayed in the Flash Memory Data window can be specified in the Memory Options screen. See chapter 5.2 Read group for details.

When the 'Copy' button is clicked, then the contents of the read target device memory will

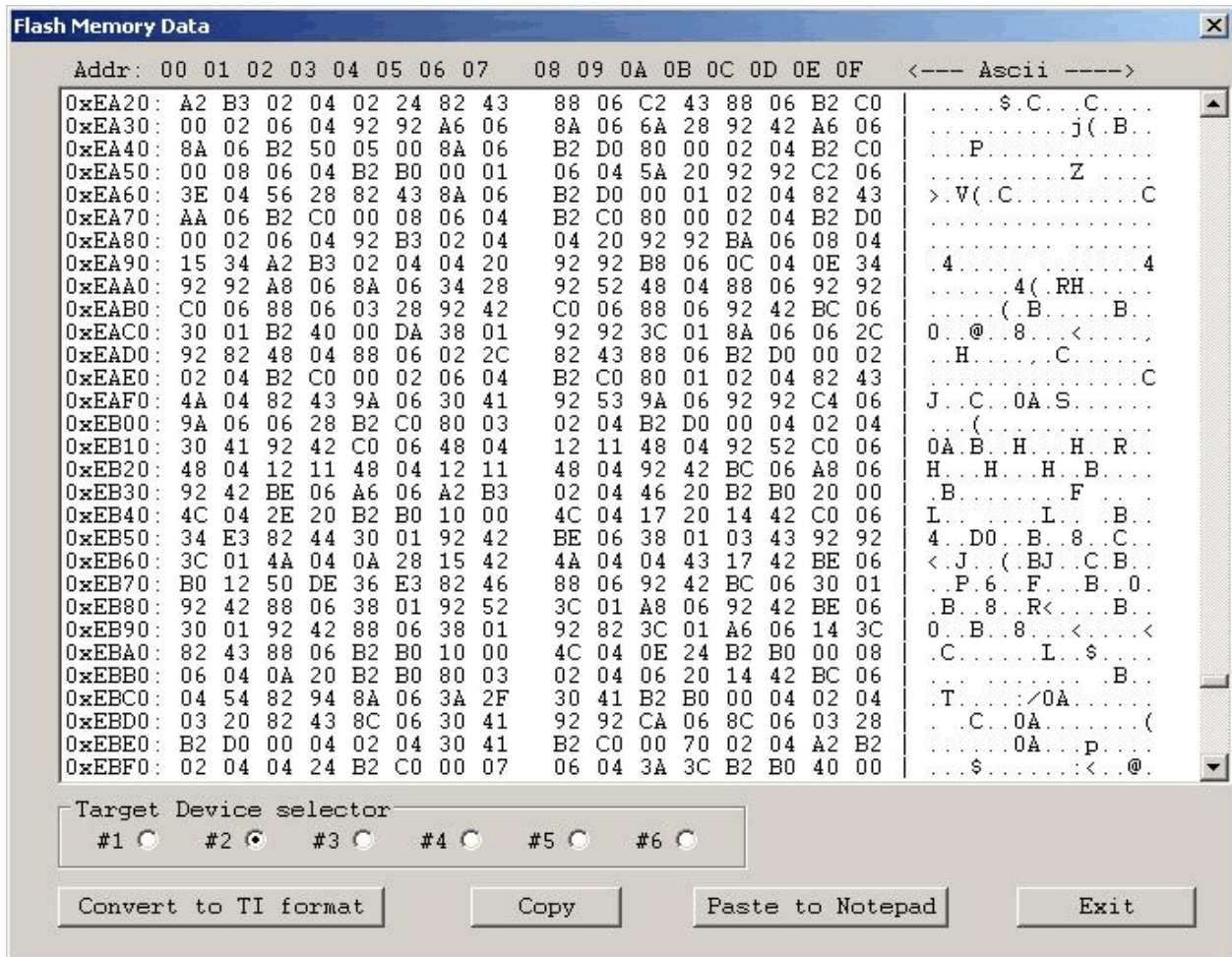

Figure 4.6.7-1

be saved in the specified by user file name and opened as a current Code File. Also programmer setup will be modified for the copy procedure. Especially the serialization will be disabled and the **'All Memory'** option will be selected in the **'Write/Erase/Verify Address Range'**. Following message will be displayed.

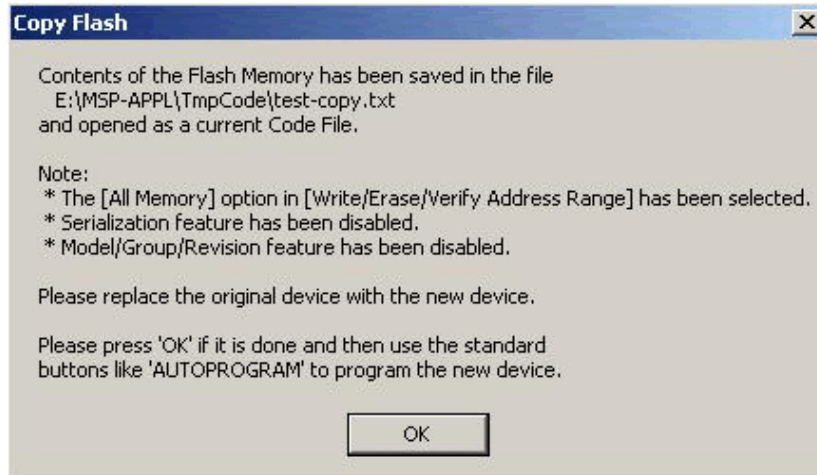

Figure 4.6.7-2

When the button pressed then programmer is ready to program the destination device.

' O K ' i s

4.7 Next button

The **'Next'** button is a dynamically programmable device action button, which is very useful in production process. After opening the program, **'NEXT'** button is disabled (see Fig.4.7-1). When any button from the **Device Action** group is pressed, then button **'NEXT'** takes the name and feature of that button. For example, if **Auto Program** button has been used, then it's name will be displayed on top of the **'NEXT'** button (see Fig.4.7-2). From now the button **'NEXT'** will perform the same function as the **Auto Program** button. The **'NEXT'** button has a shortcut to function key **F5**. Button **'NEXT'** will retain its functionality until some other device key is clicked. For example, if key **READ FLASH** is clicked, then from this moment button **'NEXT'** will take a name and feature of the **'READ FLASH'** button (see Fig.4.7-3). The read flash procedure will be called, if button **'NEXT'** or function key **F5** is pressed.

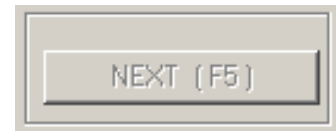

Figure 4.7-1

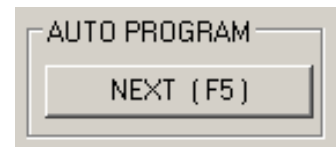

Figure 4.7-2

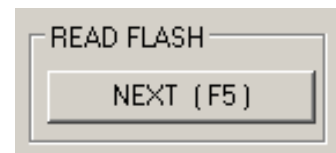

Figure 4.7-3

5. Data viewers

The contents of the code file or the Flash memory can be displayed, or compared to one another in a data viewer. To display the contents of a code file select the **'Code File Data'** option from the **'View'** menu. Similarly, the contents of the Flash memory can be displayed by selecting the **'Flash Memory Data'** option from the **'View'** menu. Please note that in order to view the contents of the Flash Memory the **'Read Flash'** option must be selected first.

When one of the above options is selected the code data viewer, shown in figure 5-1, will appear. The code viewer displays data in three columns. The leftmost column shows the code address. The middle column shows the data at the specified address in a hex format. The data is separated into byte size chunks for easy viewing. The data itself can be a hexadecimal value between 00 and FF, or '..'. If two dots appear at any location in the middle column of the code viewer then

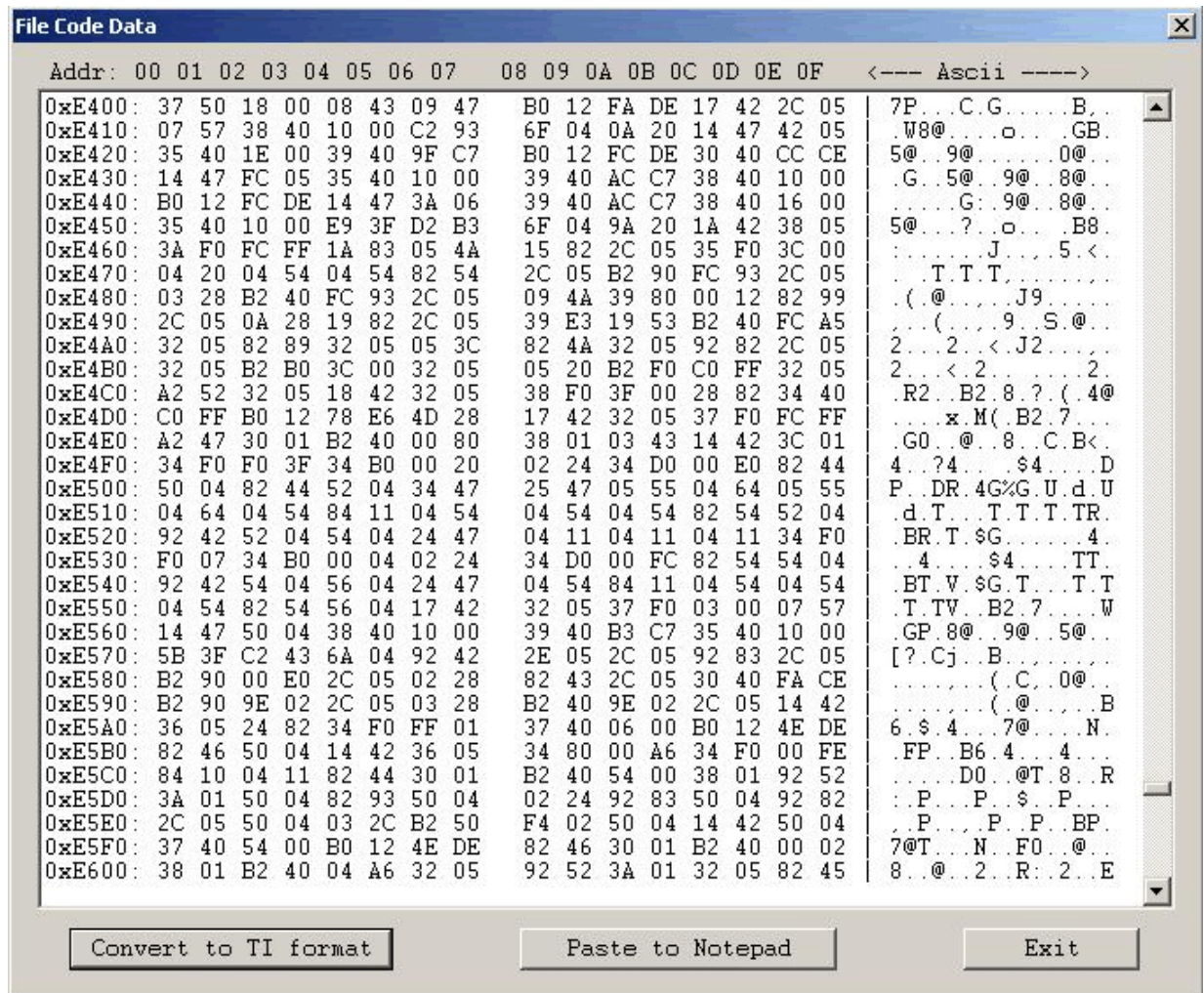

Figure 5-1

it means that the code file does not specify the contents of that memory location. Alternatively, if the data is read from the Flash memory then two dots will appear if the memory address specified is outside of the Flash Memory Space. In such a case, the following warning message will appear:

```
'::= Data out of the Flash Memory Space of the selected device =='
```

The rightmost column of the code viewer shows the same data as in the middle column, except that it is shown in the ASCII format.

The data displayed in the code viewer window can be converted to the Texas Instruments *.txt file format by clicking on the **'Convert to TI format'** button. The data will be displayed in the Notepad Editor.

Finally, the contents of the Code File data and Flash Memory Data can be compared and differences displayed in a the viewer by selecting **'Compare Code & Flash Data'** from the **'View'** menu. Only data that are not the same in the code file data and the Flash memory will be displayed. In the first line code file data will be displayed, and in the second line - Flash memory data (Figure

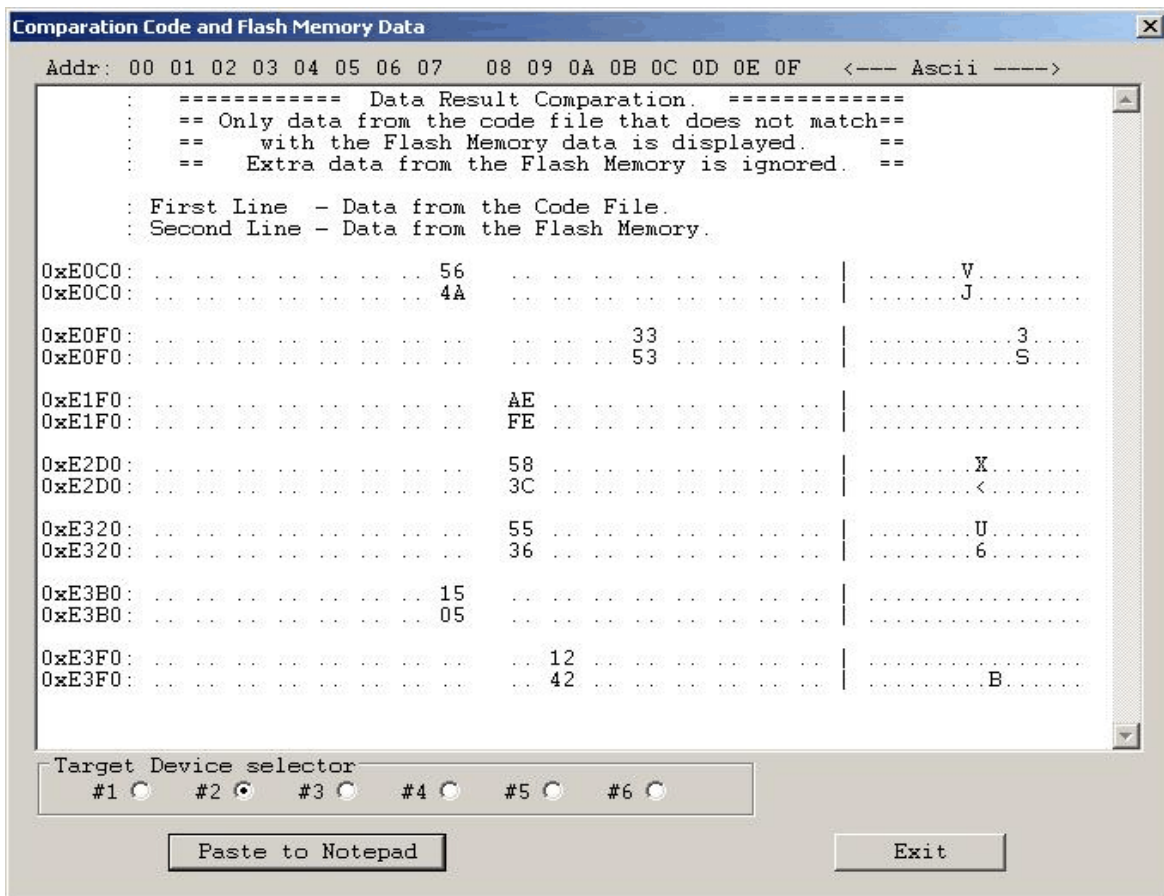

Figure 5-2

5-2).

Note: Only data at the addresses specified in the code file can be displayed. Any data not specified in code file will not be displayed, even if the Flash Memory data contains any not empty (FF) data.

6. Memory Option Dialogue Screen

The Memory Options Dialogue Screen (Fig.6-1) has five settings groups and one information group. Two of the settings groups allow the user to specify four flash memory segments for erase, write and read operation to be specified. The third settings group, write verification, allows the user to select the verification method for *Auto Program* procedure. The information group contains the start and stop address of the user specified main memory segment that can be erased, written and verified independently.

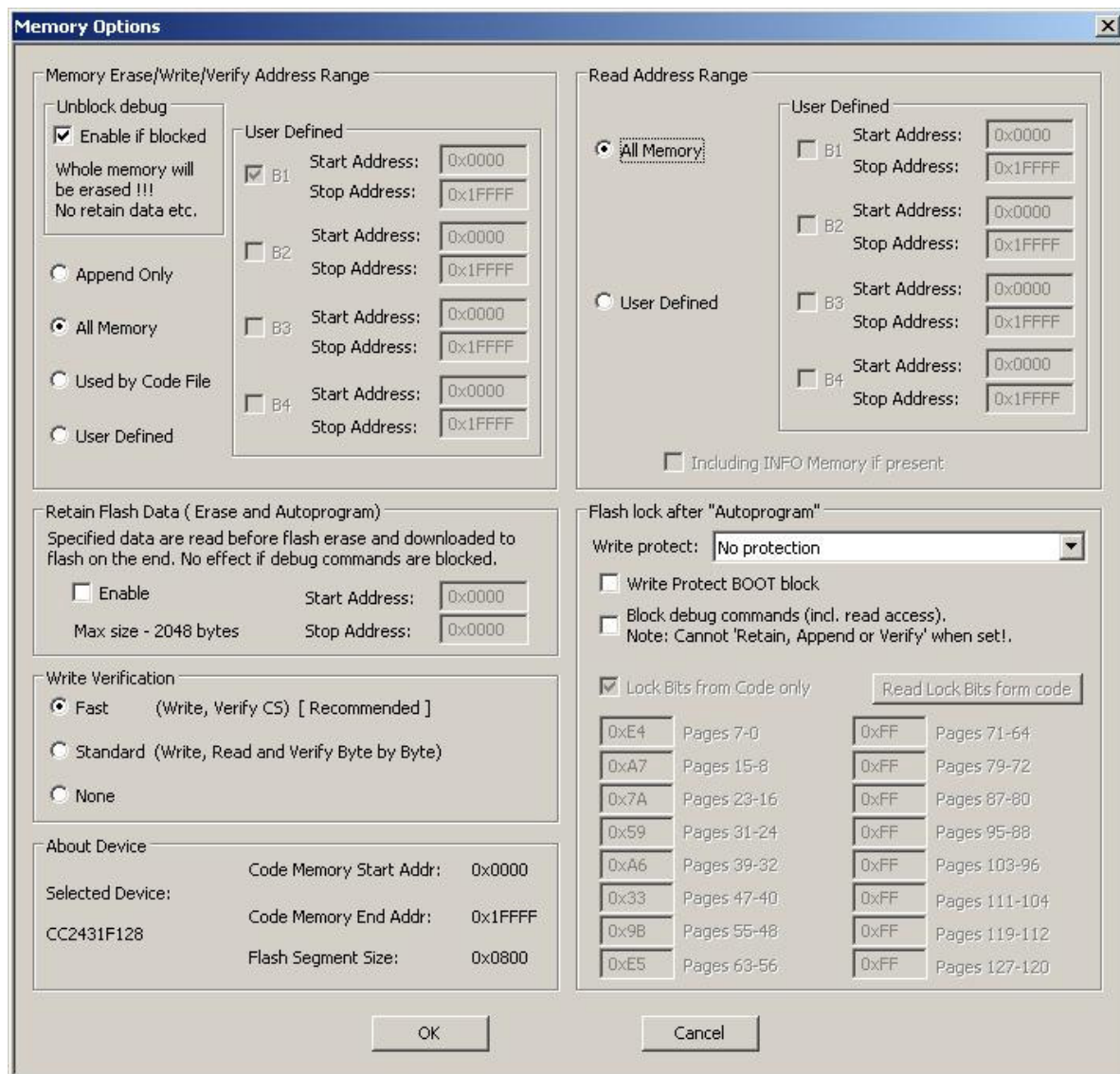

Figure 6-1

6.1 Memory Erase/Write/Verify Group

The Memory Erase/Write/Verify Address Range group block (see Fig.6-1) specifies common addresses range for erase, write and verify operations. Memory setup has five available options:

1. **Update only:**

This option allows the user to perform an update operation. This means that when the *Auto Program* procedure is executed then the contents of the code data taken from the Code File will be downloaded to the flash memory without erasing any memory segment. This option is useful when a relatively small amount of data, such as calibration data, needs to be added to the flash memory. Flash memory space defined by Code File should be blank and the code file should contain ONLY data to be downloaded to flash memory. For example, if code file contains only data as shown in figure 6.1-1 (in Texas Instruments format) then 8 bytes of data will be written starting at location 0x1008 and 6 bytes of data starting at location 0x2200. Before writing operation, all data in the flash memory at the specified location should be blank (contain value 0xFF). The software will verify automatically if this part of memory is blank and will only proceed to program the device if verification is successful.

@1008 25 CA 80 40 39 E3 F8 02 @2200 48 35 59 72 AC B8 9

Figure 6.1-1

*Note: The addresses specified in the Code File as well as the number of bytes for each data block **must** be EVEN. The software uses word (two bytes) operation for writing and reading data. In case that the code file contains an odd number of bytes to write the data segment will be appended by a single byte containing the value 0xFF. This value will not overwrite the current memory contents, but verification process will return an error if the target device does not contain the value 0xFF at that location.*

2. **All Memory**

This is the most frequently used option during flash memory programming process. The entire memory space is cleared before programming. All contents from the code file can then be downloaded to the target microcontroller's flash memory.

3. **Main memory only**

This option allows the user to erase and program only the main memory. Flash information memory (segments A and B) will not be modified. If the code file contains data intended for these segments, the data will be ignored.

4. ***Used by code file:***

This option allows main memory segments or/and information memory segments used by data specified in code file to be erased. Flash memory segments, which do not contain any data to be written to the memory from the code file, will not be erased. This option is useful, if some data, such as calibration data, should be replaced in memory. If the code file contains some new calibration data, such as described in figure 6.1-1, then the ENTIRE information memory segment at addresses 0x1000 to 0x107F and the main memory segment at addresses 0x2200 to 0x23FF will be erased and new data at locations 0x1008 and 0x2200 will be written.

5. ***User Defined:***

This option is functionally similar to options described before, but addresses range of the erased/write/verify main memory and sectors of the information memory can be defined by the user. When the ***User Defined*** option is selected, then on the right side of the ***Memory Erase/Write/Verify Group*** two check boxes and two addresses edit lines will be enabled. The check boxes allow the user to select the information memory sectors A, or/and B to be used (erased, written, verified). Edit lines in the ***Main Memory*** group allow the user to specify the main memory address range (start and stop addresses). Start address should specify the first byte in the segment, and the stop address should specify the last byte in the segment. Since the main memory segment size is 0x200, then the start address should be a multiple of 0x200, eg. 0x2200. The stop address should specify the last byte of the segment to be written. Therefore, it should be greater than the start address and point to a byte that immediately precedes a memory segment boundary, eg. 0x23FF or 0x55FF.

6.2 ***Read Group***

The ***Read Address Range*** group block (see Fig.6-1) specifies the address range used in reading process. Memory read setup has four options available:

1. ***All Memory***
2. ***Main memory only***
3. ***Info memory only***
4. ***User Defined***

The meaning of each option is the same as for the erase/write/verify procedure. The *Info Memory only* option works the same way as *Main memory only* option described above, except that only information memory is modified.

6.3 Verification Group

Verification group setup allows the user to select one of the three write verification methods:

1. ***Fast Verification,***
2. ***Standard Verification,***
3. ***None.***

Fast Verification:

During the fast verification, each byte is verified after being written and at the end of the process the check sum is read from the flash memory and compared to calculated check sum taken from the code file.

Standard verification:

Standard verification is performed after memory write process is completed. Contents of the flash memory are read and compared with the contents of the code file. If they are the same, then verification process is successful. Typically, the standard verification procedure requires the same amount of time as the read/write procedure. Total programming time with standard verification is around two times longer than read/write procedure time.

7. Adapter Options

7.1 Communication Dialogue Box

The “*Communication Interface with Target Device*” dialogue screen enables the user to select the communication speed between programming adapter and target device - 3 or 1 Mbits/s.

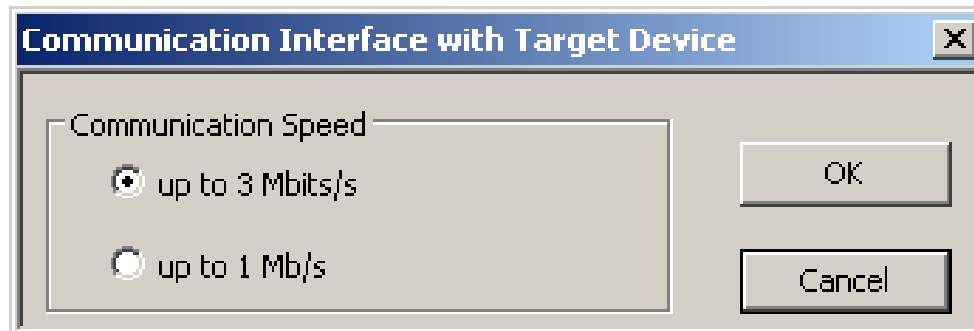

Figure 7-1

7.1.1 Communication Speed

The default communication speed between programming adapter and target device is 3 Mb/s. Under some conditions, for example when the cable between FPA and target device is long or some protection components are installed in the debug interface, the fast communication can not be used. In this case lower speed 1Mb/s can be used to establish communication between FPA and target device (see Figure 7-1 - communication speed selector).

7.2 Reset Dialogue Box

The Target’s Reset Dialogue screen enables the user to select the Reset pulse duration and reset line state at the end of programming process.

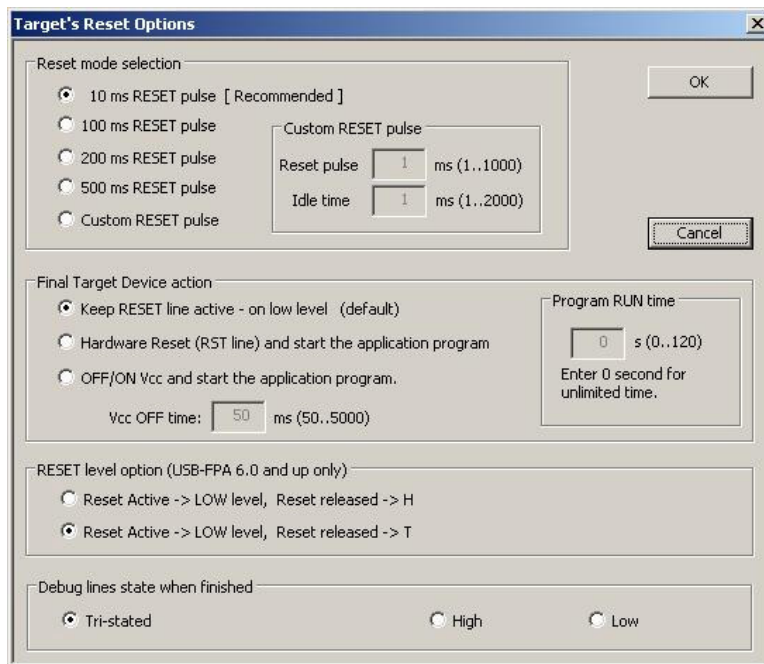

Figure 7.2

7.2.1 Reset pulse duration

The reset pulse allows the adapter to initiate communication with a microcontroller. In most cases the pulse width of 10ms is sufficient to initiate communication process. However, this may be affected by additional load on the reset line. Therefore, four additional settings, 100, 200, 500 ms and custom, are available. When the RESET IC circuit is used then the custom defined reset pulse duration can be used. Two parameters of the custom reset pulse are defined - initialization reset pulse time (typically very short - 1 ms) and an idle reset time. Idle reset time must be set at least to duration of the reset time generated by the RESET circuit.

7.2.2 Final Target Device action

Every device action, like AUTO Program, Read etc. starts with the activation of the RESET line (active low). When the device programming action begins the RESET line is raised high. When device action is finished, then RESET line is again asserted, protecting the target device from running the application program. This method is commonly used to protect the programming adapter from the DC overload. However, when target device is supplied from its own power supply, or a battery, the overload protection of the programming adapter is no longer necessary.

The target device can be set to run an application immediately after the target device is programmed. This permits verification of the programmed device if required. To do this check the

‘Hardware Reset (RST line) and start the application program’

OR

‘ON/OFF Vcc and start the application program’

option in the Reset Options window, shown in Figure 7-2. Application run time can be unlimited or limited up to 120 seconds. Limited time is specified in the **“Program RUN time”** box. When entered ‘0’ in the **“Program RUN time”** box then time is unlimited.

7.3 Options Dialogue Box

The Options Dialogue screen allows to enable or disable the report history in the report window (see figure 4.1). When enabled then the report history is displayed up to 8 kB characters (approximately 20 last communication messages). When disabled, then the only last programming report is displayed.

All programming actions at the end can generate the Beep OK tone. When a lot of units is programmed then the OK tone can be disabled just to not make a lot of noise. Error programming tone is enabled permanently and can not be disabled.

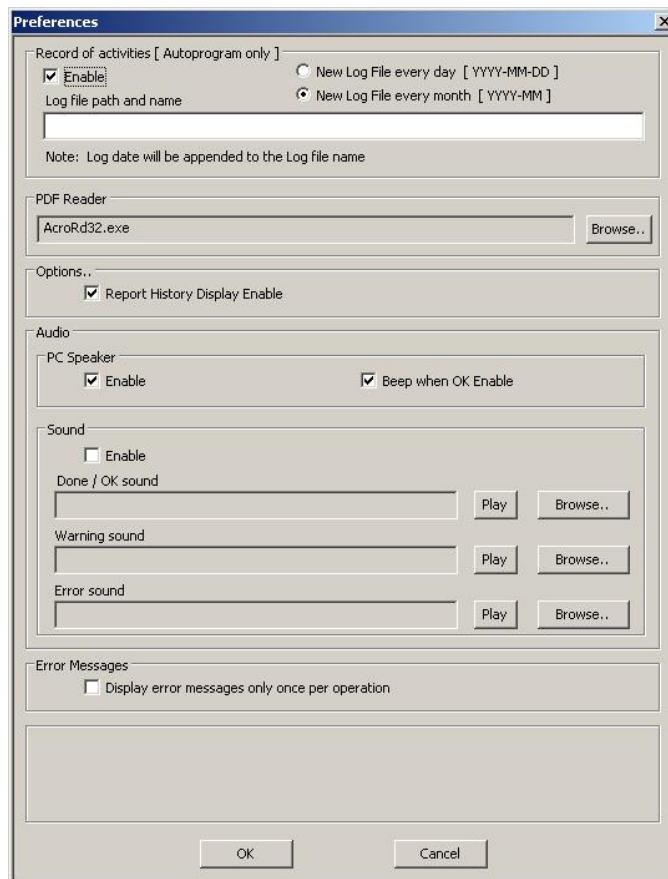

Figure 7.3

8. Serialization

8.1 Introduction

The *GangPro-CC* programming software has the ability to automatically create the target device's *IEEE Address* and *Serial Number* and save it in the flash memory. These numbers are also saved in the data base file. The new *IEEE Address* and *Serial Number* can be created automatically by incrementing the *IEEE Address* and *Serial Number* or can be taken from a file created by the user. Furthermore, model name, group, and revision can be downloaded to target device. The *IEEE Address* format is fixed and contains 8 bytes located at the end of the flash memory. The *Serial Number* format and location in the device's flash memory must be specify by the user.

Note: The Serial Number assignment option is available only when the programming adapter FPA with the standard access is used. The FPA - lite version does not have access to serialization. The IEEE Address can be created with FPA standard and lite version.

IEEE Address and *Serial Number* are created when the *Auto Program* or *Write SN /Write IEEE Addr* button is pressed and the Serialization feature is enabled. When the *Auto Program* function is activated then the *IEEE Address* and/or *Serial Number* are programmed to the target device's memory along with the code data. If the *Auto Program* function fails for any reason then new *IEEE Address / Serial Number* is not created.

The software also allows the device to retain its *IEEE Address / Serial Number* if one has already been assigned to it. Every time a device is programmed and serialization is enabled the contents of the target's memory are scanned for existing *IEEE Address* and *Serial Number*. If numbers are found in the database, the dialogue screen (see Figure 8.1) will appear and allow you to decide if you wish to keep the old *IEEE Address / Serial Number*, new or manually entered once. When the edited numbers are used, then it is possible to press the "*Verify with Data Base*" button and check if the entered *IEEE Address / Serial Number* have been already used before. On the right side of each edited number will be displayed message "*OK*" if the number has not been used before, or "*used*" when it was (see Figure 8.1).

Serial Number Editor

All Target's...
 All New...
 All Edited...

IEEE address

	Target's IEEE addr.	New IEEE addr.	Edited IEEE addr.	
#1	<input type="radio"/> 00 11 11 11 11 11 11 17	<input checked="" type="radio"/> 00 11 11 11 11 11 11 21	<input type="radio"/> 00 11 11 11 11 11 11 21	OK
#2	<input type="radio"/> 00 11 11 11 11 11 11 18	<input checked="" type="radio"/> 00 11 11 11 11 11 11 22	<input type="radio"/> 00 11 11 11 11 11 11 22	OK
#3	<input type="radio"/>	<input type="radio"/>	<input type="radio"/>	
#4	<input type="radio"/>	<input type="radio"/>	<input type="radio"/>	
#5	<input type="radio"/>	<input type="radio"/>	<input type="radio"/>	
#6	<input checked="" type="radio"/> 00 11 11 11 11 11 11 19	<input checked="" type="radio"/> 00 11 11 11 11 11 11 23	<input type="radio"/> 00 11 11 11 11 11 11 23	OK

Serialization

	Target's SN	New SN:	Edited SN	
#1	<input type="radio"/> 222217	<input checked="" type="radio"/> 222221	<input type="radio"/> 222221	OK
#2	<input type="radio"/> 222218	<input checked="" type="radio"/> 222222	<input type="radio"/> 222222	OK
#3	<input type="radio"/>	<input type="radio"/>	<input type="radio"/>	
#4	<input type="radio"/>	<input type="radio"/>	<input type="radio"/>	
#5	<input type="radio"/>	<input type="radio"/>	<input type="radio"/>	
#6	<input checked="" type="radio"/> 222219	<input checked="" type="radio"/> 222223	<input type="radio"/> 222223	OK

YYMM12345678

Model, Group, Revision

	-01 5A014X02 Rev
#1	-01 5A014X02 Rev
#2	-01 5A014X02 Rev
#3	
#4	
#5	
#6	-01 5A014X02 Rev

OK

VERIFY with Data Base

Cancel

Figure 8.1

8.2 IEEE Address & Serialization Dialogue Screen

IEEE Address & Serialization dialogue box, shown in figure 8-2, allows the user to configure of the *IEEE Address* and *Serial Number* serialization process. The *IEEE Address Write* option can be selected from the pull down *IEEE Address* option list. Serialization (*Serial Number*) can be enabled, or disabled, by selecting the check mark in the ENABLE Serialization box. When serialization is disabled, then all edit lines and check boxes are disabled. When serialization is enabled all fields must be set.

IEEE Address & Serialization Setup

IEEE Address Setup

IEEE Address Write to Flash option: Autoprogram -> Write IEEE address from the file

IEEE Address Start from: 0x 00 00 00 00 00 00 00 00

IEEE Address increment: 0x 00 00 00 00 00 00 00 01

Default IEEE address location (8 bytes at the end of the flash memory)

Defined IEEE address location (all bytes must be located in one flash sector) 0x00000 Even Address only

IEEE Address data in Flash - LSB First

SN / IEEE Record File c:\test\ieee.sn

Warn if Device's Flash Memory is not empty on the IEEE Address or SN location

Serialization Setup

ENABLE Remove code contents in the location where the serialization and model.. are defined

Serial Number Format

Display Format

- YYYY-1234(5)
- YYMM-1234(5)
- YYMMDD-1234
- YYDDD-1234(5)
- 12345678
- 1234(5)
- Custom 6 char. (4..256)
- From File

In Memory Format

- HEX (MSB First)
- HEX (MSW First)
- HEX (LSW/LSB First)
- BCD
- Ascii

Memory Location

SN Start Address in Memory: 0xFFE0 Used size: 6 bytes

Serial Number (date excluded) starting from: 0

Serial Number Increment: 1

Model / Group / Revision

ENABLE Start Address in Memory: 0xFFFF0 Size in Bytes: 16 (1..32)

Ascii -01 5A014X02 Rev-2 0 bytes

Refresh / Verify Cancel OK / Exit

Figure 8-2

8.2.1 IEEE Address selection

The GangPro-CC software allows to create IEEE Address in the target device. Format and location in flash of the created IEEE Address is fixed and contains 8 bytes located at the end of available flash memory location. For example, the IEEE Address in a CC2431F128 device is saved at location 0x1FFF8 to 0x1FFFF. All eight bytes must be specified.

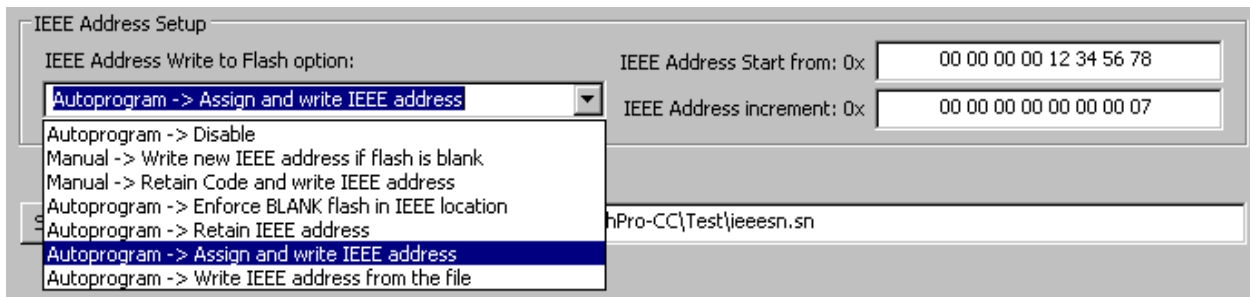

Figure 8.3

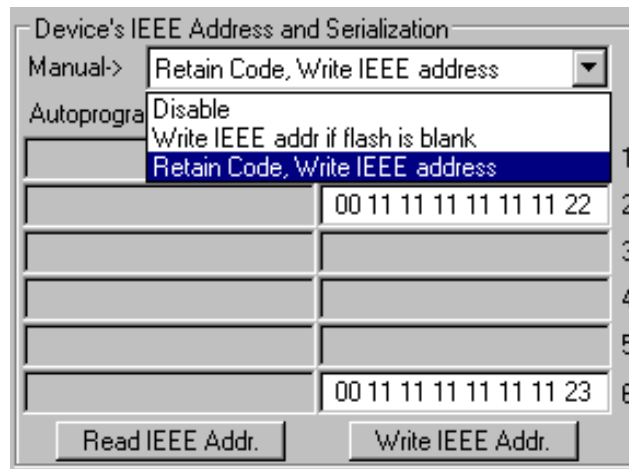

Figure 8.4

The IEEE Address selection depends on the option used to program the target device. When using the *Autoprogram* option, the *IEEE Write Address* is specified in the IEEE Address Setup (see Figure 8.3). When the user wishes to manually program the target device, then the IEEE Address can be specified in through the Device's IEEE Address and Serialization group (see Figures 4.1 and 8.4).

The above settings are used by the software depending on which programming mode is used (Autoprogram or manual). For example, in the main dialogue screen the option "*Retain Code, Write IEEE address*" can be selected and in the serialization dialogue screen - the "*Assign and write*

IEEE address” option. When the Autoprogram button is pressed, then the IEEE address will be assigned automatically (selected option **“Assign and write IEEE address”**) and when the saved IEEE address should be modified, then the new number can be modified manually (editing required number in the edit line) and downloaded to device using **“Write IEEE addr”** button. The **“Retain Code, Write IEEE address”** option will be used when the **“Write IEEE addr”** button is pressed.

The following IEEE Address Write options are available:

1. Autoprogram -> Disable
 2. Manual -> Write new IEEE address if flash is blank
 3. Manual -> Retain Code and write IEEE address
 4. Autoprogram -> Enforce BLANK Flash in IEEE location
 5. Autoprogram -> Retain IEEE address
 6. Autoprogram -> Assign and write IEEE address
 7. Autoprogram -> Write IEEE address from the file
-
1. When the IEEE Address option is disabled, then the location in the IEEE address is not used and not verified.
 2. **Manual -> Write new IEEE address if flash is blank** - used only when the **“Write IEEE addr”** button is pressed in the **Main Dialogue** screen (Figure 4.1 and Figure 8.4). The software first verifies if all eight bytes are not programmed (all 0xFF). If they are not then the action is terminated. Otherwise, the new IEEE address is downloaded and verified. The verified IEEE address is then displayed in the grey line - on the left side of the edited line (figure 8.2.1-2).
 3. **Manual -> Retain Code and write IEEE address** - used only when the **“Write IEEE addr”** button is pressed in the **Main Dialogue** screen. The software first verifies if all eight bytes are not programmed (all 0xFF). If not then the action is terminated. Otherwise, the new IEEE address is downloaded and verified. When the bytes in the IEEE address locations are not blank, then whole sector (1 or 2 kB) is read, erased, and the new IEEE Address saved and all data restored. The contents of the whole sector are verified. The new IEEE address is displayed in the grey line.
 4. **Autoprogram -> Enforce BLANK Flash in IEEE location** - used only when the **“Autoprogram”** action is executed. The IEEE address location will be blank (all 0xFF). Any specified data at this location (eg. in code file) will be ignored. This empty location can be used in the future for the IEEE address assignment.
 5. **Autoprogram -> Retain IEEE address** - used only when the **“Autoprogram”** action is executed. When this option is selected, then the software reads the IEEE address saved in the device, clears the flash memory contents (entire memory or just the specified segments), and

downloads the code to the target device and restores the IEEE address used initially by the target device.

6. ***Autoprogram -> Assign and write IEEE address*** - used only when the “***Autoprogram***” action is executed. This option allows to automatically assign the IEEE address and save it in target device. Downloaded IEEE address is also saved in the data base file. When the next IEEE address is created, then the data base file is scanned and the highest IEEE address is selected. The new IEEE address is equal the highest number saved in the data base plus IEEE address increment specified in the ***IEEE Address increment*** (see figure 8.2). If the new IEEE address is lower then the address specified in the ***IEEE Address start from*** filed then the higher IEEE address is used.
7. ***Autoprogram -> Write IEEE address from the file*** - used only when the “***Autoprogram***” action is executed. This option allows the software to take IEEE address from the custom defined IEEE addresses in the file and save it in target device. Downloaded IEEE address is also saved in the database file. Any HEX numbers can be used as the IEEE address. See chapter 9 for data format used in the file.

Location of the IEEE address data can be specified or used as default (see Figure 8.2). When the default location is used then the IEEE address data are saved in the last eight bytes in the available Flash memory. For example, when the flash size is 128 kbytes, then IEEE address is saved in locations 0x1FFF8 to 0x1FFFF. The IEEE address data can be saved in the Flash starting from the lowest byte (when the ***IEEE Address data in Flash - LSB First*** is selected) or from the highest byte (when the ***IEEE Address data in Flash - LSB First*** is not selected).

8.2.2 IEEE/SN Record File

The ‘IEEE/SN Record File’ specifies the full path and file name where the database contents will be saved. The IEEE Address and Serial Number file contains following data, separated by tabulation:

1. IEEE Address (16 characters - 8 bytes in hex),
1. Serial Number Format (F0,F1,F2,F3,F4,F5,F6,F7),
2. Serial Number,
3. IEEE/SN action type (New SN, unmodified SN, overwritten SN, manual SN)
4. Time and date, when SN has been created,
5. Code File Name
6. Model text.

Below is an example of the data file, containing data from the three consecutively created serial numbers.

```
0123456789abcdef F0      200300011 . m ( Sat, Mar 29,2003, 10:09 ) AS010X02-1v2.txt -01 R.0003-04-17
0011223344556678 F0      200300012 . . ( Sat, Mar 29,2003, 10:43 ) AS010X02-1v2.txt -01 R.0003-04-17
0011223344556679 F0      200300013 . u ( Sat, Mar 29,2003, 10:43 ) AS010X02-1v2.txt -01 R.0003-04-17
```

IEEE Address and Serial number can be created as a unique SN per target device's type, or as a unique SN for any device type.

8.2.3 Serial number formats

Programming software has seven methods for creating a serial number, referred to as *Display format*, and four methods of storing the SN in the memory, referred to as *In Memory Format* in the serialization dialogue screen. When a serial number is created, current date (if required) is taken from the PC timer. Make a sure that your computer has the correct date and time.

Display Formats:

1. YYYY-1234(5) - (SN Format - **F0**) Serial number has 8 or 9 characters. First four characters contain current year, and remaining 4 or 5 characters contain the serial number, eg. SN 20030123 or 200300123 has a number 0123 (or 00123) created in the 2003 year.
2. YYMM-1234(5) - (SN Format - **F1**) Serial number has 8 or 9 characters. First two characters contain last two digits of current year, next two characters contains current month, and remaining 4 or 5 characters contain a number, eg. SN 03030123.
3. YYMMDD-1234 - (SN Format - **F5**) Serial number has 10. First six characters contain date (year, month, day of month) and remaining 4 characters contain a number, eg. 0405120123.
4. YYDDD-1234(5) - (SN Format - **F4**) Serial number has 9 or 10. First five characters contain date (year, day of year from 1 to 366) and remaining 4 or 5 characters contain a number, eg. 041230123.
5. 123456768 - (SN Format - **F2**) 8 digits serial number without date stamp.
6. 1234(5) - (SN Format - **F3**) 4 or 5 digits serial number without date stamp.
7. Custom - (SN Format - **F6**) 4 to 16 Ascii characters or hexadecimal numbers entered manually or from the Bar-Code Reader.
8. From the file - (SN Format - **F7**) 4 to 16 ASCII characters or hexadecimal numbers taken from the user created file.

When the serials number formats 1 through 6 are selected, then in the dialogue screen all numbers are displayed and edited as a decimal numbers. Only numeric keystrokes from **0** to **9** will be accepted. All displayed numbers (decimal) are converted to the format HEX, BCD or ASCII before they are saved to flash memory.

When the *Custom* or *From the file* serial number is selected, then any keystroke is accepted. When the ASCII format is selected, then entered SN is saved as is in the flash memory. When the Hex format is selected, then only the HEX characters can be used (0...9,A,B,C,D,E,F).

HEX (MSW first) and HEX (LSW first) format:

When hex format is selected, then all SN display formats described above can be stored as a one or two integer (16-bits - 2 bytes) numbers. First four display characters will be saved as one hex integer number and remaining five characters will be saved as a second hex integer number. When format *HEX(MSW first)* is selected then the first hex integer number is saved as a first word and the second number - as a next word in the Flash memory location. When format *HEX(LSW first)* is selected then the first hex integer number is saved as a second word and the second number - as a first word in the Flash memory location.

Display Format: YYYY-1234(5) - size in FLASH - 4 bytes

SN 200300123 will be saved as

YYYY - 2003	(Decy)	->	0x07D3	(hex)
12345 - 00123		->	0x007B	(hex)

In flash memory this number can be seen as

07D3	007B	->	<i>HEX(MSW first)</i>
007B	07D3	->	<i>HEX(LSW first)</i>

when integer numbers are viewed, or as

<--- Hex format bytes--->				(Size - 4 bytes)
D3	07	7B	00	-> <i>HEX(MSW first)</i>
7B	00	D3	07	-> <i>HEX(LSW first)</i>

when bytes are viewed (first byte is the LSW byte from the integer number)

Displayed consecutive serial number (16-bits integer number) can have a value from 0 to $(2^{16}-1)$ equal 65535 and is displayed as the 5 digits serial number.

Display Format: YYMM-1234(5) - size in FLASH - 4 bytes

SN 030300123 will be saved as

YYMM - 0303 (Decy) -> 0x012F (hex)
12345 - 00123 -> 0x007B (hex)

In flash memory this number can be seen as

012F 007B -> *HEX(MSW first)*
007B 012F -> *HEX(LSW first)*

or

<--- Hex format bytes---> (Size - 4 bytes)
2F 01 7B 00 -> *HEX(MSW first)*
7B 00 2F 01 -> *HEX(LSW first)*

Display Format: YYMMDD-1234 - size in FLASH - 4 bytes

The format date is compressed to be able to fit data in only in two bytes as follows:

Bit 15 14 13 12 11 10 9 8 7 6 5 4 3 2 1 0
<---(year-2000)----> < month><— day -->

SN 0405110123 will be saved as

YYMMDD - 040511 (Decy) -> 0x08AB (hex)
1234 - 0123 -> 0x007B (hex)

In flash memory this number can be seen as

08AB 007B -> *HEX(MSW first)*
007B 08AB -> *HEX(LSW first)*

or

<--- Hex format bytes---> (Size - 4 bytes)
AB 08 7B 00 -> *HEX(MSW first)*
7B 00 AB 08 -> *HEX(LSW first)*

Display Format: YYDDD-1234 - size in FLASH - 4 bytes

The format date is compressed to be able to fit data only in two bytes as follows:

Bit 15 14 13 12 11 10 9 8 7 6 5 4 3 2 1 0
<---(year-2000)----> < --- day of year --->

SN 041110123 will be saved as

YYDDD - 04111 (Decy) -> 0x086F (hex)
1234 - 0123 -> 0x007B (hex)

In flash memory this number can be seen as

086F 007B -> *HEX(MSW first)*
007B 086F -> *HEX(LSW first)*

or

<--- Hex format bytes---> (Size - 4 bytes)
6F 08 7B 00 -> *HEX(MSW first)*
7B 00 6F 08 -> *HEX(LSW first)*

Display Format: 123456768 - size in FLASH - 4 bytes

SN 12345678 will be saved as

12345678 (Decy) -> 0x00BC614E (hex)

In flash memory this number can be seen as

00BC 614E -> *HEX(MSW first)*
614E 00BC -> *HEX(MSW first)*

or

<--- Hex format bytes---> (Size - 4 bytes)
00 BC 4E 61 -> *HEX(MSW first)*
4E 61 00 BC -> *HEX(LSW first)*

Display Format: 1234(5) - size in FLASH - 2 bytes

SN 12345 will be saved as

12345 (Decy) ---> 0x3039 (hex)

In flash memory this number can be seen as

3039 (integer numbers) -> *HEX(MSW first)* or *HEX(LSW first)*

or

<--- Hex format bytes---> (Size - 2 bytes)
39 30 (bytes) -> *HEX(MSW first)* or *HEX(LSW first)*

BCD format:

When BCD format is selected, then all SN display formats described above can be stored as a two or four separate bytes converted to BCD format, where first and last four bits of 8 bit byte

contains a value from 0 to 9. All consecutive serial number characters are converted to half byte each. Finally two consecutive serial number characters will be converted to a single byte.

Display Format: YYYY-1234 - size in FLASH - 4 bytes

SN 20030123 will be saved as

YYYY - 2003	->	0x20 0x03	(bytes)
1234 - 0123	->	0x01 0x23	(bytes)

When flash memory bytes are viewed, then this number can be seen as

<--- Hex format bytes--->
20 03 01 23 (Size - 4 bytes)

The consecutive serial number (4 bytes BCD) can have a value from 0 to 9999 and is displayed as the 4 digit serial number.

Display Format: YYMM-1234 - size in FLASH - 4 bytes

SN 03030123 will be saved as

YYMM - 0303	->	0x03 0x03	(bytes)
1234 - 0123	->	0x01 0x23	(bytes)

In flash memory this number can be seen as

<--- Hex format bytes--->
03 03 01 23 (Size - 4 bytes)

Display Format: YYMMDD-1234 - size in FLASH - 5 bytes

SN 0405110123 will be saved as

YYMMDD - 040511	->	0x04 0x05 0x11
1234 - 0123	->	0x01 0x23

In flash memory this number can be seen as

<--- Hex format bytes--->
04 05 11 01 23 (Size - 5 bytes)

Display Format: YYDDD-1234 - size in FLASH - 4 bytes

The format date is compressed to be able to fit data only in two bytes as follows:

Bit 15...12 - Year number - multiple of ones (9,8,...1,0)
11,10 - Year number - multiple of tens (3,2,1,0)
9, 8 - Day number - multiple of hundreds (3,2,1,0)
7...4 - Day number - multiple of tens (9,8,...1,0)
3...0 - Day number - multiple of ones (9,8,...1,0)

SN 041110123 will be saved as

YYDDD - 04111 (Decy) -> 0x41 0x11 (hex)
1234 - 0123 -> 0x01 0x23 (hex)

Display Format: 12345678 - size in FLASH - 4 bytes

SN 12345678 will be saved as

12345678 -> 0x12 0x34 0x56 0x78 (bytes)

In flash memory this number can be seen as

<--- Hex format bytes--->
12 34 56 78 (Size - 4 bytes)

Display Format: 1234 - size in FLASH - 2 bytes

SN 1234 will be saved as

1234 -> 0x12 0x34 (bytes)

In flash memory this number can be seen as

<--- Hex format bytes--->
12 34 (Size - 2 bytes)

ASCII format:

When Ascii format is selected, then all SN display formats described above can be stored as a four or eight separate bytes converted to Ascii characters. All consecutive serial number characters are converted to Ascii characters.

Display Format: YYYY-1234

- size in FLASH - 8 bytes

SN 20030123 will be saved as

YYYY - 2003

-> 0x32 0x30 0x30 0x33 (bytes)

or '2' '0' '0' '3'

1234 - 0123

-> 0x30 0x31 0x32 0x33 (bytes)

or '0' '1' '2' '3'

When flash memory bytes are viewed, then this number can be seen as

<----- Hex format ----->

<- Ascii format ->

32 30 30 33 30 31 32 33

20030123

(Size - 8 bytes)

Display Format: YYMM-1234

- size in FLASH - 8 bytes

SN 03030123 will be saved as

YYMM - 0303

-> 0x30 0x33 0x30 0x33 (bytes)

or '0' '3' '0' '3'

1234 - 0123

-> 0x30 0x31 0x32 0x33 (bytes)

or '0' '1' '2' '3'

In flash memory this number can be seen as

<----- Hex format ----->

<- Ascii format ->

30 33 30 33 30 31 32 33

03030123

(Size - 8 bytes)

Display Format: YYMMDD-1234

- size in FLASH - 10 bytes

SN 0405110123 will be saved as

YYMMDD - 040511

-> 0x30 0x34 0x30 0x35 0x31 0x31 (bytes)

or '0' '4' '0' '5' '1' '1'

1234 - 0123

-> 0x30 0x31 0x32 0x33 (bytes)

or '0' '1' '2' '3'

In flash memory this number can be seen as

<----- Hex format ----->

<- Ascii format ->

30 34 30 35 31 31 30 31 32 33

0405110123

(Size - 10 bytes)

Display Format: YYDDD-1234

- size in FLASH - 9 bytes

SN 042140123 will be saved as

YYDDD - 04214 -> 0x30 0x34 0x32 0x31 0x34 (bytes)
 or '0' '4' '2' '1' '4'
1234 - 0123 -> 0x30 0x31 0x32 0x33 (bytes)
 or '0' '1' '2' '3'

In flash memory this number can be seen as

<----- Hex format -----> <- Ascii format ->
30 34 32 31 34 30 31 32 33 042140123 (Size - 9 bytes)

Display Format: 12345678 - size in FLASH - 8 bytes

SN 12345678 will be saved as

12345678 -> 0x31 0x32 0x33 0x34 0x35 0x36 0x37 0x38 (bytes)

In flash memory this number can be seen as

<----- Hex format -----> <- Ascii format ->
31 32 33 34 35 36 37 38 12345678 (Size - 8 bytes)

Display Format: 1234 - size in FLASH - 4 bytes

SN 1234 will be saved as

1234 -> 0x31 0x32 0x33 0x34 (bytes)

In flash memory this number can be seen as

<----- Hex format -----> <- Ascii format ->
31 32 33 34 1234 (Size - 4 bytes)

Display Format: *Custom or from the file* - size in FLASH - defined size in bytes

Taken from the file or entered manually Ascii string will be saved in the flash memory.

When the *Ascii* format is selected, then the Ascii string is saved in memory **“as is”**.

All Ascii characters can be used. For example the entered following string

02WX24S234

will be saved in memory as

30 32 57 58 32 34 53 32 33 34 -> "02WX24S234"

When the **HEX** format is selected, then the string is converted to HEX format (only hex characters are accepted - 0, 1, 2, 3, 4, 5, 6, 7, 8, 9, A, B, C, D, E, F).

All two character pairs are converted to hex format and saved in memory.

For example the entered following string

02A3B109E12F

will be saved in memory as

HEX(MSW first) -> 02 A3 B1 09 E1 2F

or **HEX(LSW first)** -> 2F E1 09 B1 A3 02

Location in the target device's flash memory, where the described above bytes are saved, is specify in the '**Memory Location - SN Start Address in Memory**' field of the serialization dialogue screen (see figure 8.2-1). Specified address must be even and should be specified in the empty memory space, not used by program code or data block

8.2.4 Model, Group, Revision

Custom text or data (hex), saved in target device's flash memory is a string or data, up to 32 characters (bytes) long, in Ascii or hex format. It can contain any text or data, but this feature is intentionally created to allow the hardware model, revision and group to be saved. Typically the object code does not contains this kind of information, but it may be useful in some applications.

This feature is enabled when the check box **ENABLE** in the **Model/Group/Revision** field is marked (see figure 8.2-1). When enabled, the size of desired text or data must be specified in the field '**Size in Bytes**'. Size value can be any *even* number between 2 and 32. The location of the text/data in the flash memory can be specified in the field '**Start Address in Memory**'. Similarly to the location of the serial number, the specified address must be even and must be specified in the empty memory space, unused by program code or data block. Otherwise, the error message will be displayed.

The text to be saved in the flash memory can be entered in the edit line. Bytes can be entered as an Ascii, if **Ascii** option is selected, or in hex bytes, if the **Hex** option is selected. When the **Ascii/Hex** selector is modified, then the contents data is displayed as an Ascii string or as a hex bytes data.

8.2.5 Device Serialization box

Device Serialization box, located on the main programming dialogue screen (see figures 8-2 and 4-1) contains IEEE Addresses, serial number and model information. The left columns contains information taken from the target devices, and the right columns - pending data to be saved. Whenever a communication with the target device is performed the IEEE Address and serial number is read and displayed in the Device Serialization group (Figure 8.5). IEEE address or serial number displayed in the white fields can be manually modified if required. The manually entered numbers can be saved using Autoprogram option, or using manual buttons located inside the *Device's IEEE Address and Serialization* group. When the next time the Autoprogram action is selected, then the

next IEEE Address or SN is generated automatically, according to the setup in the *Serialization* . This means that any data entered in the '*Device Serialization*' group can be treated as temporary data and downloaded to the target devices.

Device's IEEE Address and Serialization			
Assign and write IEEE address		-01 3A014X02 rev	
70 C7 4F C0 40 2B B4 06	70 C7 4F C0 40 2B B4 0D	1	20071234 20071236
70 C7 4F C0 40 2B B4 06	70 C7 4F C0 40 2B B4 14	2	20071235 20071237
		3	
		4	
		5	
		6	
Read IEEE Addr.		Write IEEE Addr.	
Read SN		Write SN	

Figure 8.5

Current target's label (IEEE Address, serial number and model text) can be read at any time by pressing **READ IEEE Addr.** and **READ SN** buttons located in the '*Device Serialization*' group (see figure 8.5)

When the Autoprogram action is selected and the *IEEE Address / Serialization* is enabled, then the current data saved in target device is read first. If target device already contains IEEE

Address and/or serial number, or the IEEE Address and/or serial number have been modified manually, then the following IEEE/SN edit dialogue screen is displayed (Figure 8.1). In this screen all IEEE Addresses and serial numbers are displayed - taken from current target devices, pending new data created automatically, and data edited manually. Each line contains selector, that allows to accept desired data to be downloaded to target device - taken from current device, created automatically, or modified manually for each target device separately.

8.3 Serialization Report Dialogue Screen

Serialization Report Dialogue Screen reports the results of the serialization procedure. The report contains the detailed information of the two highest serial number programmed units, quantity of programmed units along with the new created serial numbers, unmodified SN (reprogrammed units), manually created SN and quantity of the overwritten SN. Detailed information about all programmed units can be viewed using the Notepad text editor by pressing the **'NotePad'** button.

Short information of the created serial numbers, format, date and time of programming is

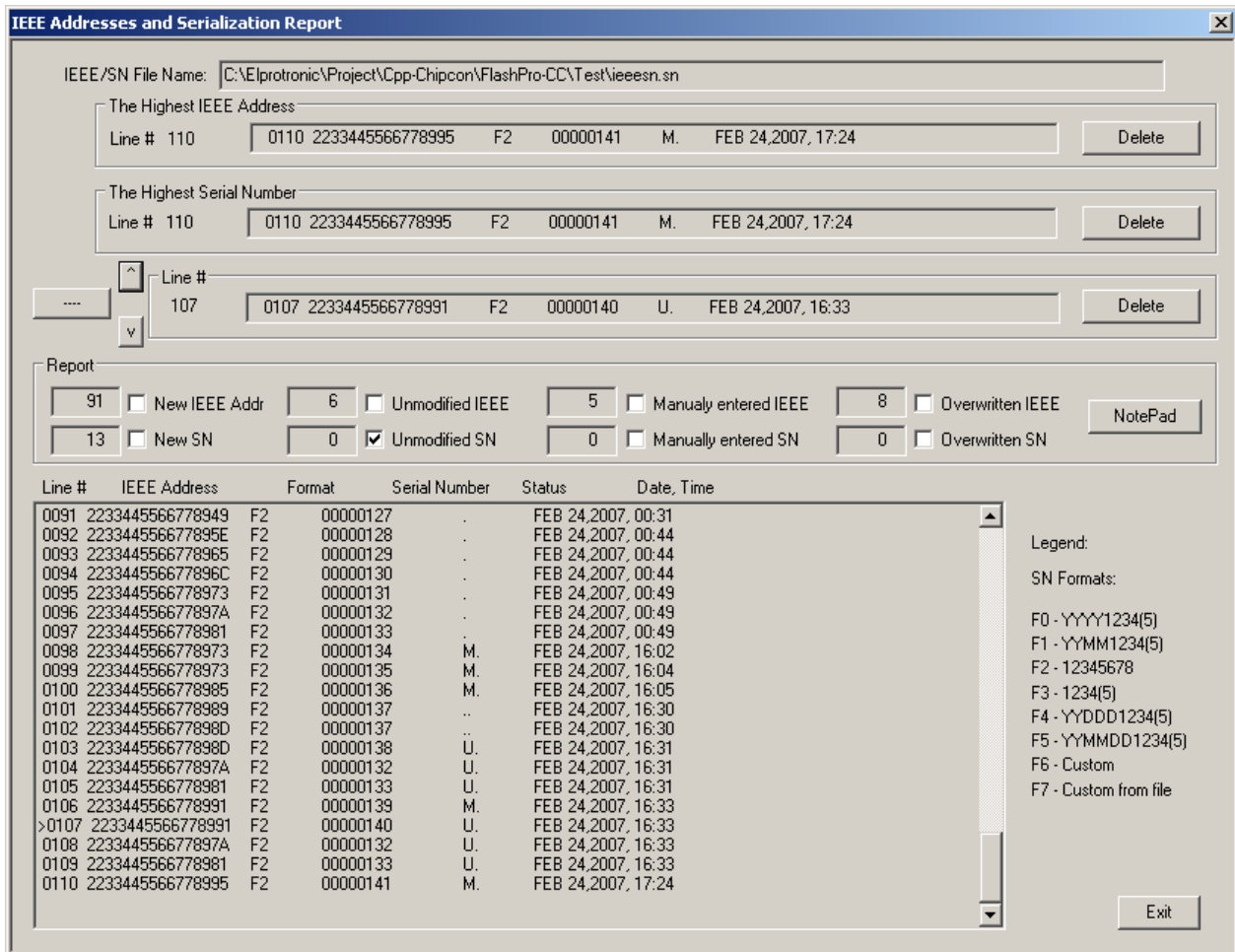

Figure 8.6

displayed on the white report box (see Figure 8.3-1). IEEE/ SN are created automatically via software by incrementing the highest IEEE/SN taken from the serial number files. If from any reason the highest IEEE Address or Serial Number is wrong it can be removed from the database by

pressing the ***Delete*** button. Note that the delete operation is not reversible. Third line allows to select any line from the report information and delete it if required. Selected line is marked in the report window with character '>' on the left of the selected line.

9. IEEE /SN data file

The GangPro-CC software allows the user to download the IEEE Address and/or serial number from custom defined data file. When the data file is used then in the *IEEE Address Write to Flash option* the *Write IEEE address from the file* option should be selected (see Figure 8.2), and in serialization the *Serial Number Format* field should be set to *From File*.

The IEEE/SN data file can contains list of IEEE Addresses, list of serial numbers of both - pairs of the IEEE Addresses and serial numbers. Format of the IEEE addresses data is fixed and contain 8 bytes data in hex format. Format of the serial numbers can be specified in the serialization dialogue screen (Figure 8.2). The IEEE/SN data file can be created in any text editor.

All data specified after semicolon (;) are ignored and can be used by user as a comments. On the top of the data the IEEE/SN file should contain header data. When the header is specified, then list of desired IEEE Addresses and/or serial numbers can be listed. Following list of commands started from # can be specified in the header:

#IEEE_SN_LIST

Data file contains IEEE addresses and serial numbers.

#IEEE_LIST

Data file contains only IEEE addresses.

#SN_LIST

Data file contains only Serial number list.

#SN_SIZE number ;optional

Overwrite size of the custom defined serial number size (see Figure 8.2). If the #SN_SIZE is not specified, then the data specified in the serialization dialogue screen is used.

#IEEE_PREFIX hex numbers ;optional

#IEEE_SUFFIX hex numbers ;optional

#SN_PREFIX string ;optional

#SN_SUFFIX string ;optional

The IEEE Address that contains 8 bytes in hex (16 characters) can be specified in fully, or can be combined from the fixed prefix, fixed suffix and listed part of the individual number. In total this combination of data must contains 16 characters (8 bytes). For example following IEEE addresses list

1111213330012222
1111213330022222
1111213330032222

.....
1111213331202222

can be grouped from two the same data block and from one modified as follows

#IEEE_PREFIX 111121333
#IEEE_SUFFIX 2222

and list of variable IEEE Addresses list

001
002
003

.....
120

Prefix and /or suffix numbers can be modified in the list if required, eg.

#IEEE_PREFIX 111121333
#IEEE_SUFFIX 2222
001
002
003
#IEEE_PREFIX 333121333
001
002
003

that defined IEEE addresses

1111213330012222
1111213330022222
1111213330032222
3331213330012222
3331213330022222
3331213330032222

#SN_PREFIX string ;optional
#SN_SUFFIX string ;optional

Similar to IEEE prefix/suffix - the serial number string can be combined from SN prefix, suffix and variable SN part.

Example of the IEEE Address / Serial Number list (5 lines only in this example)

```
; =====  
; IEEE Address /Serial Number List  
; first col - IEEE address, second col - SN  
; SN format - Ascii  
; =====  
#IEEE_SN_LIST  
#SN_SIZE 12  
  
01C2220000010022 WX5E2007001P  
01C2220000020022 WX5E2007002P  
01C2220000030022 WX5E2007003P  
01C2220000040022 WX5E2007004P  
01C2220000050022 WX5E2007005P
```

The same IEEE Address / Serial Number list with specified prefix /suffix

```
; =====  
; IEEE Address /Serial Number List  
; first col - IEEE address, second col - SN  
; SN format - Ascii  
; =====  
#IEEE_SN_LIST  
#SN_SIZE 12  
#SN_PREFIX WX5E2007 ;any Ascii character  
#SN_SUFFIX P  
#IEEE_PREFIX 01C222000 ;hex only  
#IEEE_SUFFIX 0022  
  
001 001  
002 002  
003 003  
004 004  
005 005
```

The same IEEE Address / Serial Number list with specified prefix only

```
; =====  
; IEEE Address /Serial Number List  
; first col - IEEE address, second col - SN  
; SN format - Ascii
```

```

; =====
#IEEE_SN_LIST
#SN_SIZE      12
#SN_PREFIX    WX5E2007          ;any Ascii character
#IEEE_PREFIX  01C222000        ;hex only

0010022      001P
0020022      002P
0030022      003P
0040022      004P
0050022      005P

```

When writing a new IEEE Address, or SN, entry the IEEE Address/SN can be compared to those stored in the IEEE/SN data file. To do so, the data file should be specified in the *SN/IEEE Record file* field (see Figure 8.2). When the desired *IEEE Address Write option* and *Serial Number Format* is selected using the data from the file, then using the *SN/IEEE file* button located in the main dialogue screen (Figure 4.1) the desired IEEE/SN file should be opened. Selected file is converted to final format and all listed IEEE addresses and serial numbers are verified in the data base file against usage. If specified IEEE addresses or SN have been used before, then these numbers are removed from the pending list. When the IEEE/SN file is read and verified, then the current pending list is displayed in the screen (Figure 9.1) with extra information on the top

- * number of the IEEE/SN found in data base and removed from the pending list
- * number of the IEEE addresses with incorrect size and removed from the pending list
- * number of the Serial Numbers with incorrect size and removed from the pending list
- * number of the accepted IEEE/SN

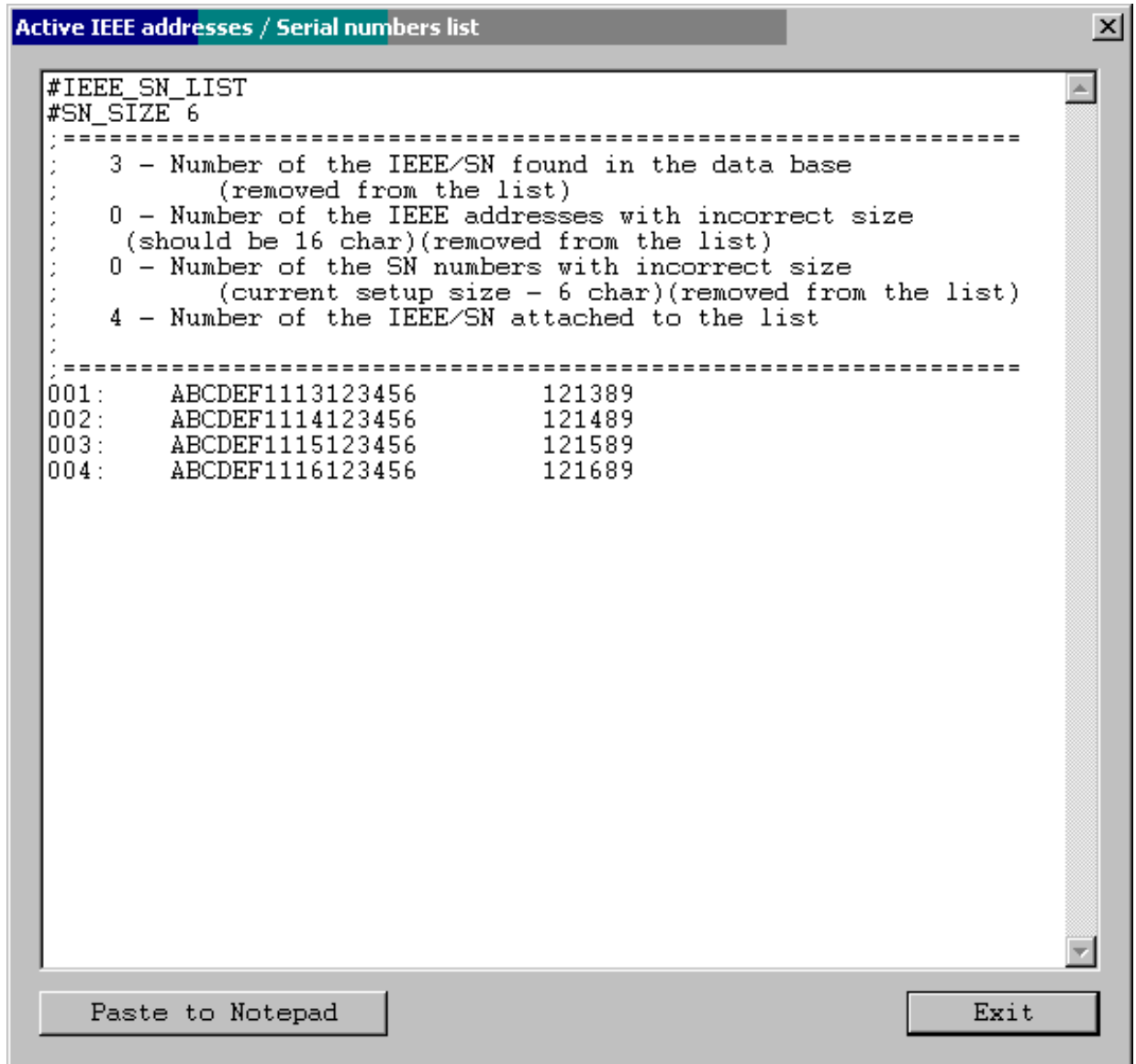

Figure 9.1

When the *“Paste to Notepad”* button is pressed, then the pending IEEE addresses /Serial Number list can be saved in format ready to be used as a valid IEEE/SN file if required.

10. Check Sum Options

Programming software has two groups of check sum (CS) calculation. The first group is used for internal programming verification and the second group can be used for firmware verification in application software.

The CS used for internal verification is calculating CS only for specified words in the code file regardless of the flash memory size, location etc. This CS is useful only inside the programmer, because programmer has all information about programmed and empty bytes location. This method is also useful if only part of the code is programmed in the flash (append option). All not programmed words in the programming process are ignored, even if these words are not empty in the flash.

The check sum used for internal programming verification is displayed in the Check Sum Group (Figure 10.1) (see the Main Dialog screen - Figure 4.1)

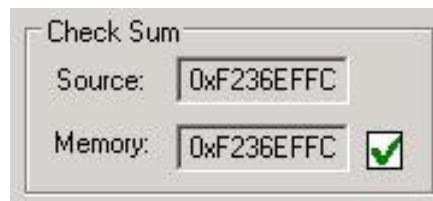

Figure 10.1

In the source line is displayed the arithmetic sum of the code contents with added contents of the serialization, model etc. if selected. Arithmetic sum is calculated as the sum of 16-bits unsigned words - result is 32 bits unsigned. Only programmed words are taken for calculation. All other not used words are ignored. All bytes are converted to 16-bits words as follows (for simplicity - format casting is not present in this example):

$$\text{word} = \text{data}[\text{address}] + (\text{data}[\text{address}+1] \ll 8)$$

where address is even and incremented by 2.

In the memory line is displayed the CS result taken from the flash memory, calculated in the same way as the CS taken from the source. Only words defined in the source are taken from the flash memory for calculation.

Second group of the CS is custom defined Check Sum that can be used by firmware for code verification in the flash. Up to four CS block can be specified and CS results can be saved in the flash for verification. Size of each CS block and CS result location in flash are defined by the user. The Check Sum Options dialog (figure 10-2) is selected from following pull down menu:

Setup -> Check Sum Options

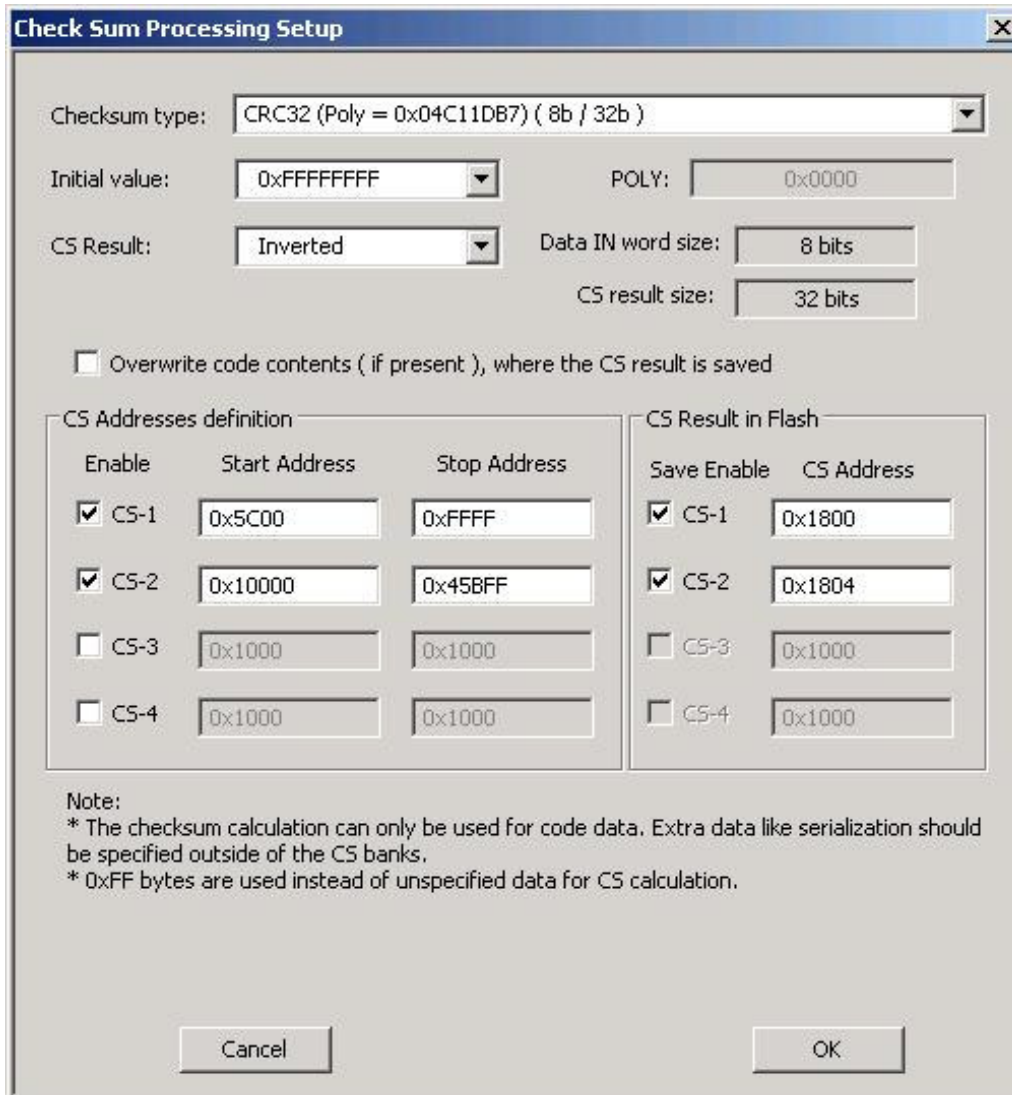

Figure 10.2

Start Address should be even, and the Stop Address should be odd. CS result address in the flash should be even. Make sure that the CS result is saved out of the CS block space. Otherwise the CS result will modify the contents of the CS inside the specified block. CS result after the second calculation would not be the same and CS result would be useless.

When the **CS Result Save** option is not selected then the CS of the selected block is calculated and CS result displayed in the report window only (Figure 10.3). This option can be used for CS code verification defined as the code form Start to End Addresses with 0xFF data in the not specified code location.

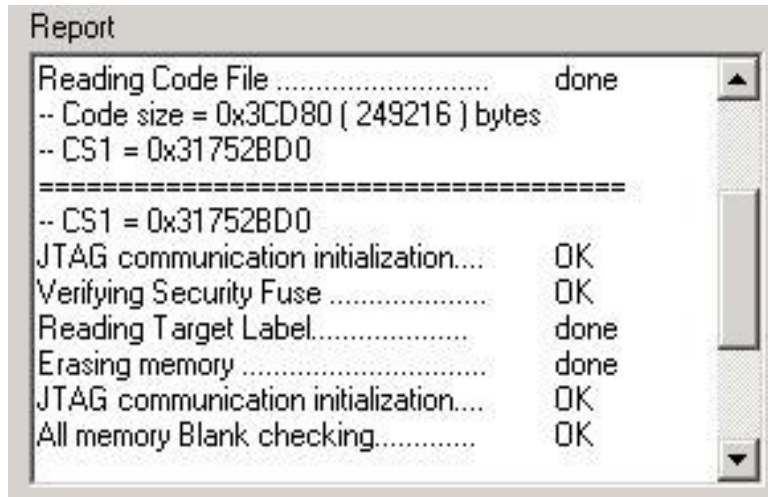

Figure 10.3

Type of the CS can be selected from the following list (Figure 10.4)

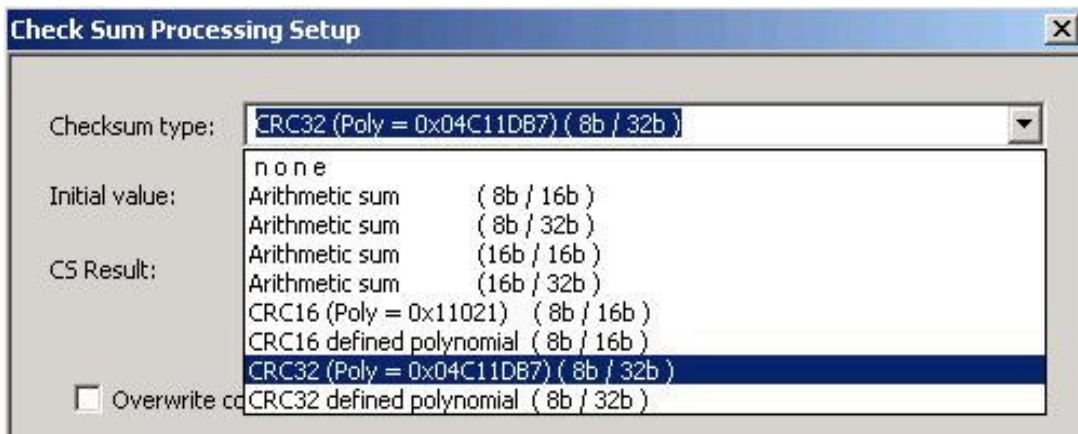

Figure 10.4

Initial value for CS calculation can be selected as zero, all 0xFFs or as the Start Address from pull down menu (Figure 10.5).

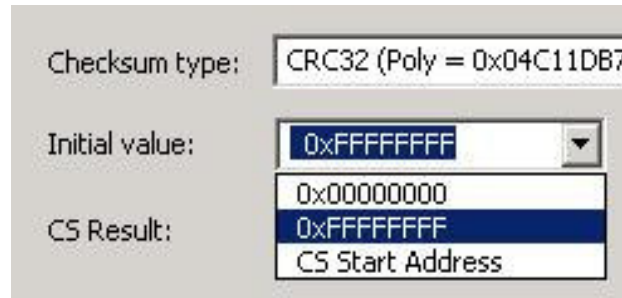

Figure 10.5

CS result can be used *As Is* or can be *inverted* (Figure 10.6).

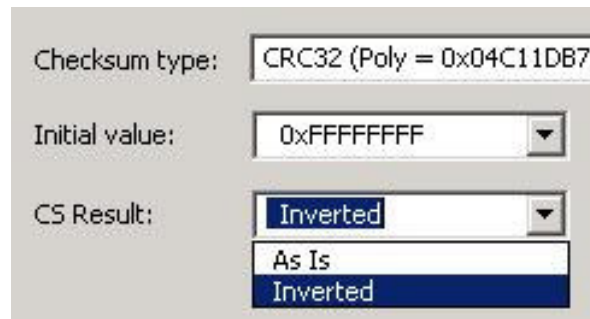

Figure 10.6

Data size (byte or 16 bits word) used for calculation and CS result size is displayed in the dialog screen as *Data IN word size* and *CS Result size* (Figure 10.2). Polynomial contents (if required) can be specified in the POLY edit line in HEX format (eg. 0x1234).

10.1 Check Sum types

Following Check Sum types are implemented (Figure 10.4)

Arithmetic Sum (8b / 16b)

Check Sum is calculated as modulo 16-bits sum of all bytes (unsigned) from Start to the End Addresses as follows

```
CS = CS_initial_value;
for ( addr = StartAddress;  addr <= EndAddress; addr++ )
{
```

```

    CS = CS + (unsigned int) data[addr];
}
CS = 0xFFFF & CS;
if( cs_inverted )
    CS = 0xFFFF ^ CS;

```

Arithmetic Sum (8b / 32b)

Check Sum is calculated as modulo 32-bits sum of all bytes (unsigned) from Start to the End Addresses as follows

```

CS = CS_initial_value;
for ( addr = StartAddress;  addr <= EndAddress; addr++ )
{
    CS = CS + (unsigned long) data[addr];
}
CS = 0xFFFFFFFF & CS;
if( cs_inverted )
    CS = 0xFFFFFFFF ^ CS;

```

Arithmetic Sum (16b / 16b)

Check Sum is calculated as modulo 16-bits sum of all 2-byte words (unsigned) from Start to the End Addresses as follows

```

CS = CS_initial_value;
for ( addr = StartAddress;  addr <= EndAddress; addr=addr+2 )
{
    CS = CS + (unsigned int)data[addr] + (unsigned int)data[addr+1];
}
CS = 0xFFFF & CS;
if( cs_inverted )
    CS = 0xFFFF ^ CS;

```

Arithmetic Sum (16b / 32b)

Check Sum is calculated as modulo 32-bits sum of all 2-byte words (unsigned) from Start to the End Addresses as follows

```

CS = CS_initial_value;
for ( addr = StartAddress;  addr <= EndAddress; addr=addr+2 )
{
    CS = CS+(unsigned long)data[addr] + (unsigned long)data[addr+1];
}

```

```

}
CS = 0xFFFFFFFF & CS;
if( cs_inverted )
    CS = 0xFFFFFFFF ^ CS;

```

CRC16 (Poly 0x11201) - (8b / 16b) (Named as CRCCCITT)
and
CRC16 defined polynomial - (8b / 16b)

Check Sum is calculated as CRC16 from each bytes from Start to the End Addresses as follows

```

CS = CS_initial_value;
for ( addr = StartAddress;  addr <= EndAddress; addr++ )
{
    CS = CS_CRC16_8to16( (long)data[addr], CS );
}
CS = 0xFFFF & CS;
if( cs_inverted )
    CS = 0xFFFF ^ CS;

```

where

```

unsigned long    CS_CRC16_8to16( long data, unsigned long crc )
{
    unsigned long tmp;
    tmp = 0xFF & ((crc >> 8) ^ data );
    crc = (crc << 8) ^ crc_tab32[tmp];
    return( 0xFFFF & crc );
}

```

The CRC table is generated first as follows:

```

CS_init_crc16_tab( 0x1021 );           for CRC CCITT
CS_init_crc16_tab( CRC_def_POLY );    for CRC16 defined polynomial

```

where

```

void CS_init_crc16_tab( unsigned short poly )
{
    int i, j;

```

```

unsigned short crc, c;

for (i=0; i<256; i++)
{
    crc = 0;
    c   = ((unsigned short) i) << 8;

    for (j=0; j<8; j++)
    {
        if ( (crc ^ c) & 0x8000 )
            crc = ( crc << 1 ) ^ poly;
        else
            crc =  crc << 1;
        c = c << 1;
    }
    crc_tab32[i] = (unsigned long)(0xFFFF & crc);
}
}

```

CRC32 (Poly 0x04C11DB7) - (8b / 32b) (Named as IEEE 802-3)

and

CRC32 defined polynomial - (8b / 32b)

Check Sum is calculated as CRC32 from each bytes from Start to the End Addresses as follows

```

CS = CS_initial_value;
for ( addr = StartAddress;  addr <= EndAddress; addr++ )
{
    CS = CS_CRC32_8to32( (long)data[addr], CS );
}
CS = 0xFFFFFFFF & CS;
if( cs_inverted )
    CS = 0xFFFFFFFF ^ CS;

```

where

```

unsigned long    CS_CRC32_8to32( long data, unsigned long crc )
{
    return( ((crc >> 8) & 0x00FFFFFF) ^ crc_tab32[0xFF & (crc ^ data) ] );
}

```

The CRC table is generated first as follows:

CS_init_crc32_tab(0x04C11DB7) for IEEE 802-3

a polynomial of

$x^{32} + x^{26} + x^{23} + x^{22} + x^{16} + x^{12} + x^{11} + x^{10} + x^8 + x^7 + x^5 + x^4 + x^2 + x + 1$

and

CS_init_crc32_tab(CRC_def_POLY) for CRC32 defined polynomial

where

```
void CS_init_crc32_tab( unsigned long poly_in )
{
    int n, k;
    unsigned long c, poly;

    poly = 0L;
    for (n = 0; n < 32; n++)
    {
        poly <<= 1;
        poly |= 1L & poly_in;
        poly_in >>= 1;
    }

    for (n = 0; n < 256; n++)
    {
        c = (unsigned long )n;
        for (k = 0; k < 8; k++)
            c = c & 1 ? poly ^ (c >> 1) : c >> 1;
        crc_tab32[n] = c;
    }
}
```

11. Script File - defined programming sequence

Programming sequence can be customized when is using a script file. Script file prepared as a text file (using any editor like **notepad**) can contains customized programming sequences in any order. Generally, all buttons available on the main dialogue screen can be used in the script file. All other options available on others screens like memory options, serialization type etc. can not be modified from the script file directly, but can be reloaded in fully using configuration file. From the script file any configuration files can be called at any time that allows to modify programmer configuration. This method can simplify programming process using script file and allows to use full options available in the programmer. Programming sequence conditions can be taken from user defined procedures attached as an independent DLL if required.

Programmer has two entry for taking the sequence from the script file

1. By pressing the Script File button in the Main dialog
2. By using the -rf with the executable file

11.1 Script button

The '**Script**' button is the dynamically programmable device action button that allows to take a desired action taken from the script file. The **Script** button has a name **Script File - none** (Figure 11-1) if the script file is not defined or **Script:** with used file name when the script file is active (Figure 11-2). When the **Script** button is pressed and the current script file is not active, then the **Open File** dialog is displayed and the desired script file should be selected. When the **Script file** button is not empty and the new script file if required, then the new file can be selected from the pull down menu - **File-> Open Script File**.

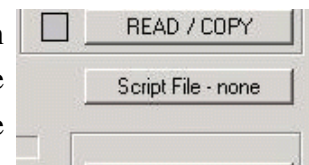

Figure 11-1

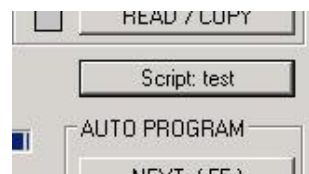

Figure 11-2

The **Script** button is very useful for implementing a short programming sequence not present directly in the **Device Action** group buttons Below is an easy script file used for downloading two independent codes to target device - first code used for hardware test if possible, and when hardware is ok, then the second code is downloaded as the final

code to target device. The same sequence can be used with other buttons, but sequence should be always repeated, that of course is not convenient.

Using the notepad editor create the script file and save it eg. as the file “*test.sf*” or any other file name. See this chapter below for all available instructions that can be used in the script file.

```
;-----  
; easy script file;  
;-----  
  
LOADCFGFILE C:\Program Files\Elprotronic\USB GangPro-CC\test.cfg  
LOADCODEFILE C:\Program Files\Elprotronic\USB GangPro-CC\test.cfg  
AUTOPROGRAM  
  
; now the hardware is tested according to downloaded firmware  
MESSAGEBOX YESNO  
    "Press YES when the test finished successfully."  
    "Press NO when the test failed."  
  
IF BUTTONNO GOTO finish  
  
LOADCFGFILE C:\Program Files\Elprotronic\USB GangPro-CC\final.cfg  
LOADCODEFILE C:\Program Files\Elprotronic\USB GangPro-CC\final.cfg  
AUTOPROGRAM  
  
>finish  
END  
;-----
```

When the script file above is used then the first configuration file and the first code file is downloaded and Autoprogram function is executed. When finished then the MCU firmware started (make sure that the first configuration allows to start the code when the Autoprogram is finished). Final code is downloaded when the test has been finished successfully.

Before running the script file the configuration files named *test.cfg* and *final.cfg* required in the project should be created using the GUI software first. To do that connect target devices to programming adapter, select desired configuration and save the configuration file as *test.cfg* and create final configuration file in similar way.

11.2 Script file option

Programming sequence can be customized when using the -rf with the executable file (described in the *“Project and Configuration Load/Save”* chapter) .

When the executable file GangPro-CC.exe is called with a script path as an argument e.g.

FlashPro-CC.exe -rf C:\Program Files\Elprotronic\USB GangPro-CC\script.txt

or when the icon with the GangPro-CC.exe and script file path is executed then programmer starts automatically programming sequences according to procedure specified in the script file. Access to other buttons are blocked. When script file sequence is finished then program is terminated. There is not option to modify the running sequence when script sequence is used. This option is useful in production, because nobody can modify sequence that has been prepared for the production purpose.

11.3 Script commands

LIMITATIONS:

1. Up to 1000 script lines commands can be used. Empty lines and lines with comments only are ignored and not counted.
2. Up to 50 CALL's deep stack is used (CALL in CALL in CALL.....).

SYNTAX:

white spaces before instructions, labels etc are ignored.

; comment - all contents after semicolon are ignored.

NOTE: Comment can not be used in the lines where the file name is specified.

>label - character '>' without spaces must be placed before label name.

NOTE: After label can not be specified any command in the same line. Line can contain label only.

LIST OF INSTRUCTIONS:

MESSAGEBOX type **FCTEXT** - pop-up message box with buttons.

- message taken from the FCONTROL function (User's DLL)

MESSAGEBOX type - pop-up message box with buttons.

“ message - line -1 “ - Text displayed in message box.

“ message - line -2 “ - Each line contents must be located between characters “ ”

“ max up to 50 lines “ - Number of content lines - up to 50 lines.

Message box type list

OK	- One button OK
OKCANCEL	- Two buttons OK , CANCEL
YESNO	- Two buttons YES , NO
YESNOCANCEL	- Three buttons YES , NO, CANCEL
GOTO label	
CALL label	- CALL procedure.
RETURN	- return from CALL.
IF condition GOTO label	
IF condition CALL label	
condition list:	
BUTTONOK	- if button OK pressed in the message box.
BUTTONYES	- if button YES pressed in the message box.
BUTTONNO	- if button NO pressed in the message box.
BUTTONCANCEL	- if button CANCEL pressed in the message box.
DONE	- if selected process e.g. AUTOPROGRAM finished successfully.
FAILED	- if selected process e.g. AUTOPROGRAM failed.
CONTROL = number	- if status from the FCONTROL function = NUMBER
FCONTROL type argument	- call the external function from FxControl DLL
PAUSE number	- pause in milliseconds - 1 to 100000 range (1ms to 100 s).
OPENDLLFILE filename	- FxControl DLL file - Full path and DLL File name.
LOADCFGFILE filename	- Configuration file - Full path and File name.
LOADCODEFILE filename	- Code file - Full path and File name.
LOADSNFILE filename	- IEEE/SN file - Full path and File name.
VCCOFF	- Turn OFF Vcc from programming adapter to target device.
VCCON	- Turn ON Vcc from programming adapter to target device.
	Note: Vcc from FPA must be enabled first using configuration file.
RESET	-equivalent to pressed button RESET on the main dialogue screen.
AUTOPROGRAM	-equivalent to pressed button AUTOPROGRAM on the main dialogue screen.
VERIFYACCESS	-equivalent to pressed button VERIFY LOCK BIT on the main dialogue screen.
ERASEFLASH	-equivalent to pressed button ERASE FLASH on the main dialogue screen.
BLANKCHECK	-equivalent to pressed button BLANK CHECK on the main dialogue screen.
WRITEFLASH	-equivalent to pressed button WRITE FLASH on the main dialogue screen.
VERIFYFLASH	-equivalent to pressed button VERIFY FLASH on the main dialogue screen.
READFLASH	-equivalent to pressed button READ/COPY on the main dialogue screen.
READSN	-equivalent to pressed button READ SN on the main dialogue screen.
READIEEE	-equivalent to pressed button READ IEEE Addr on the main dialogue screen.
LOCKFLASH	-equivalent to pressed button LOCKFLASH on the main dialogue screen.
TRACEOFF	- trace OFF.
TRACEON	- trace ON and saved in the "Trace-Scr.txt" file in current working directory.

Option useful for debugging. Trace file contains sequence of all executed commands from script file in the run time. On the left side of all lines the current line numbers correspondent to the line number in the script file are printed. Line numbers are counted without empty lines and without lines contains comments only.

END - end of script program.

Programming sequence conditions can be taken from user defined procedures attached as an independent DLL and called in the script as a function.

FCONTROL type argument - call the external function from FxControl DLL

Function should be created using Visual C++ and attached to FlashPro-CC software. When the DLL is created then the full path and name of the used DLL should be specified in the script file. In the script file the name of the desired DLL can be specified on-line few times. This means that more then one DLL can be used in the programming sequence, but only one DLL at the time. When the new DLL file is open, then the old DLL file is closed at the same time. One function is used in the user defined DLL

```
_int32 F_Control( _int32 type, _int32 argument, char * message );
```

Parameters type and argument are specified in the script file and are transferred from the programming software to DLL. Status from F_Control and message are transferred from DLL to programming software.

Programming software package contains the source code of the user defined DLL. Package has been prepared using MS Visual C++.net package. Source code is located in directory

C:\Program Files\Elprotronic\FxControl-DLL

User defined function should be inserted in empty place inside the FxControl.cpp file and recompiled. Recompiled file FxControl.dll ready to be used will be located in directory

C:\Program Files\Elprotronic\FxControl-DLL\release

DLL file can be renamed to any file name and name and specified in the script file via command

OPENDLLFILE filename

Below is an easy script file contents that allows to create following sequence;

1. Vcc supplied to target device is turn-OFF and first message box with buttons OK/CANCEL is displayed. Programmer is waiting until button OK or CANCEL is pressed.
2. When confirmed, then first configuration file **test-A.cfg** is downloaded to programmer. Configuration file **test-A.cfg** should be prepared first using programming software with desired configuration, selected desired code file etc. Programmer's configuration should be saved using "Save setup us .." option.
3. When test code is downloaded and processor started (if enabled in **test-A.cfg** file) then message box is displayed and software is waiting until button YES / NO is press. Meantime manual target's device test can be done. If test is positive, then button OK should be pressed. Or button NO if test failed.
4. When button OK has been pressed then programmer downloads **finalcode.cfg** configuration file to programmer. Current configuration can activate serialization if required, reload final code to be downloaded etc. When the new configuration is reloaded then final code is downloaded to target device, serialization is created etc.
5. On the end programmer returns to beginning and waiting for the next target device to be connected.

```

;=====
;   Script file - demo program - without DLL file
;-----
>START
  VCCOFF
  MESSAGEBOX   OKCANCEL
    "VCC if OFF now. Connect the test board."
    "When ready press the button:"
    " "
    "OK       - to test the board"
    "CANCEL  - to exit from program"

  IF BUTTONCANCEL GOTO finish

  LOADCFGFILE   C:\Elprotronic\Project\Cpp-Net\GangPro-CC\test-A.cfg

  MESSAGEBOX   OK
    "Press OK to download the test program."

  AUTOPROGRAM

  MESSAGEBOX   YESNO
    "Press YES when the test finished successfully."
    "Press NO  when the test failed."

  IF BUTTONNO GOTO START

```

```

LOADCFGFILE    C:\Elprotronic\Project\Cpp-Net\GangPro-CC\finalcode.cfg
AUTOPROGRAM
GOTO START

```

```

>finish
    END

```

```

;=====

```

Below is the next script file examples uses DLL file that allows to control testing process via function written in the DLL. Functionality is the same as in the example above, but instead manually confirmation of the test result the result is taken automatically from the DLL function. Two functions has bee used for this purpose

FCONTROL - calls external user defined function in the DLL

IF CONTROL = 0 GOTO START - test status from the FCONTROL and if result is 0 (FALSE) then procedure returns to start.

Required DLL file should be created first.

```

;=====
;    Script file - demo program - with DLL file
;-----
OPENDLLFILE    C:\Program Files\Elprotronic\FxControl-DLL\release\FxControl.dll
>START
    VCCOFF
    MESSAGEBOX    OKCANCEL
        "VCC if OFF now. Connect the test board."
        "When ready press the button:"
        " "
        "OK      - to test the board"
        "CANCEL - to exit from program"

    IF BUTTONCANCEL GOTO finish

LOADCFGFILE    C:\Elprotronic\Project\Cpp-Net\GangPro-CC\test-A.cfg

MESSAGEBOX    OK
    "Press OK to download the test program."

AUTOPROGRAM

FCONTROL 1 0          ;type 1, argument 0, but can be any
IF CONTROL = 0 GOTO START ;when false (0), return to start

IF BUTTONNO GOTO START

LOADCFGFILE    C:\Elprotronic\Project\Cpp-Net\GangPro-CC\finalcode.cfg

```



```
AUTOPROGRAM  
GOTO START
```

```
>finish  
END
```

```
;=====
```

12. Project and Configuration Load / Save

Programming software can save configuration settings in the configuration files or save the whole project configuration with used code contents and save it in the encrypted project file . This allows the user to create several configuration or project files, one for a particular task, and thus eliminates the need to manually change settings every time a different configuration is desired. Furthermore, the config.ini file contains the most recently used settings and those settings will be used as default whenever the software is started.

12.1 Load / Save Setup

To create a configuration file simply select ***Save Setup*** from the ***File*** menu. Current settings will be saved for future use. To restore configuration settings select ***Load Setup*** from ***File*** menu and select a file containing the settings you wish to restore.

In order to prevent accidental setup changes the GangPro-CC Programmer provides the option to Lock configuration settings. When the user selects the ***Lock/Unlock Setup*** option from the Setup menu, the Flash Programmer will prevent the user from modifying the setup. The only options that are available when the programmer is locked are ***Verify, Read, Autoprogram*** and ***Next***. Notice that the ***Next*** button will immediately change to implement the ***Autoprogram*** function. To unlock the programmer the user must select the ***Lock/Unlock Setup*** option from the Setup menu.

12.2 Load / Save Project

The Project option (Save/Load) contains more than the programmer configuration only, but can also the code used in the project. Contents of the project file is encrypted, so it is not possible to read the contents of the used code downloaded to target device. When the project is opened then the same decryption key must be used as it was used in the encryption process, otherwise decryption will not succeed. Encryption key depends from the used type of software (FlashPro-CC, GangPro-CC, etc.) used password or destination's PC "hardware fingerprint" number. So - the project file created with the GangPro-CC software cannot be used with the FlashPro-CC and vice-versa. Each project file should be created in the same type of software. Project file is CRC protected and CRC check is performed when the file is loaded .

Project can be unprotected or protected with the destination PC "hardware fingerprint" number or password protected. This allows to create the project that can be used only on the specific PC when the project is encrypted with the destination PC "hardware fingerprint" number (useful in

production) or create the project that can be used only when the correct password is entered every time when the project is open. Project can be unlocked or locked with almost all blocked buttons and pull down menu items. When the project is locked, then only major buttons like *Autoprogram* or *Verify* are active - and only a few pull-down menu items are accessible. All options that allows to read the code contents are blocked.

When the new project is create then it is recommended to select the *New Setup* from pull down menu and set the default option of all parameters and names used in the programmer. As the next - the desired processor, code file, password file if required and all desired option (see all available options described in this manual) should be selected. When it is done, it should be verified if programmers works as expected. When all works, then the current setup can be saved as the project file. Select the *Save Project as..* from **File** pull down menu. Following dialogue will be displayed (Figure 12.2-1) that allows to select desired project option

Following options can be selected:

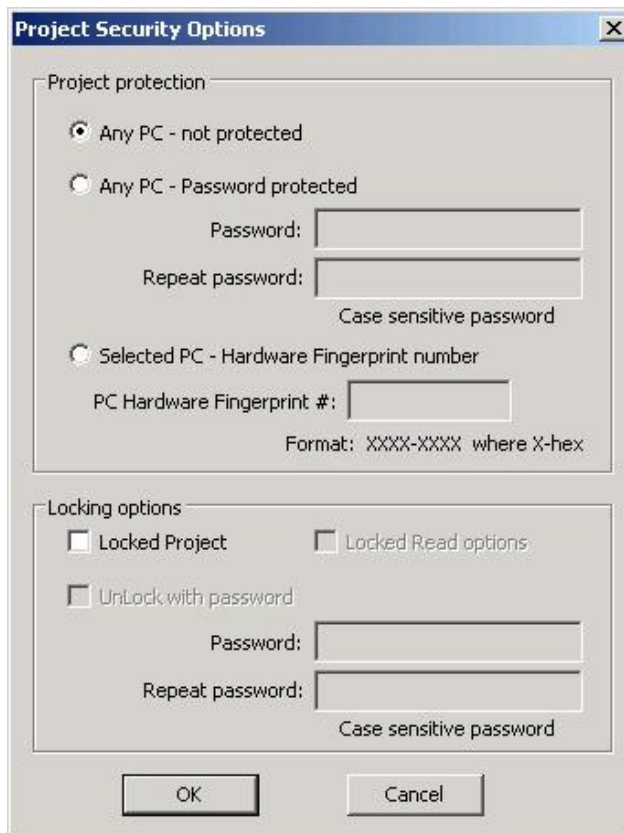

Figure 12.2-1

Project protection:

Any PC - not protected.

When this option is selected then project is not protected and can be opened on any PC without restrictions.

Any PC - Password protected.

When this option is selected then project can be opened when the password is correct. The desired password should be entered in two edit lines. Password is case sensitive and takes up to 16 characters - space including.

Selected PC - Hardware Fingerprint

When this option is selected then project can be opened only on one desired PC where the *PC's "hardware fingerprint"* number taken from the destination PC is the same as the number used when the project has been created. This option is useful in production because project can be opened automatically without password on the desired PC. The same project file cannot work on other computers. When the project is created for particular PC, then the *PC "hardware fingerprint"* number should be taken from the desired PC and entered in the edit line in dialogue screen (figure 12.2-1). This number has hardcoded format and contains eight hex characters with dash between 4th and 5th character eg.

6FA4-E397

Notice, that the project created with the desired *PC's "hardware fingerprint"* number will not work on the PC where the project has been created, because *"hardware fingerprint"* numbers on the destination PC and the PC used for creating a project are not the same. It is possible to create the project with the *PC's "hardware fingerprint"* number taken from his own PC, create a project and check if work as expected. When all is OK, then project should be saved again with the desired *PC's "hardware fingerprint"* number.

PC's "Hardware fingerprint" number used with the project can be read by selecting the *"PC Hardware fingerprint number"* option from pull down menu

About/Help -> PC Hardware fingerprint number

Following message box is displayed when the option above is selected (figure 12.2-2)



Figure 12.2-2

Locking option:

Locked Project

1. When not selected, then project is not locked. All contents can be modified and all buttons are accessible.
2. When selected then project is locked. Almost all buttons are disabled (grayed) and almost all items in the pull down menu are disabled.

When the project is locked, then it is possible to select - permanently lock project, or select an option that it is possible to unlock the project under password. The unlock password can be not the same as the password used for opening the project.

Locked Read options

When selected then the code viewers and READ button are blocked and not allows to read the code contents downloaded to target device. If the security fuse is blown after programming the target device, then code cannot be seen by the staff downloading code to target devices.

Unlock with password

When project is locked then it is possible to select option “unlock with password” and specify up to 16 characters unlocking password. Password is case sensitive. On the figure 12.2-3 is a “Project Security Options” dialogue screen with selected options

Project protected with *PC's “hardware fringerprint”* number, locked and unlocked with password.

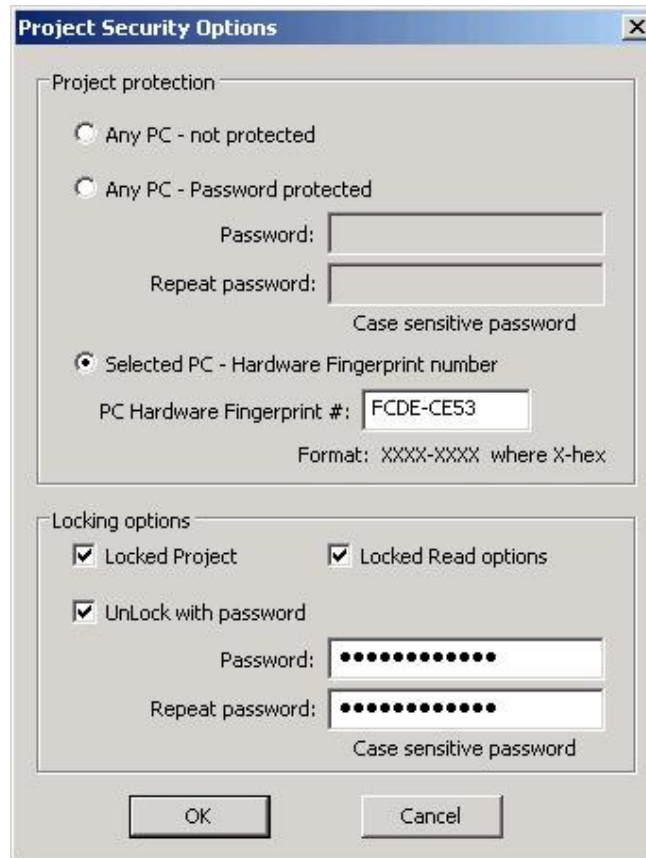

Figure 12.2-3

By default, project is not protected and not locked. This allows to create unprotected project and open it at any time on any PC without restrictions. All buttons and items on the dialogue screen are not blocked.

12.3 Commands combined with the executable file

Project file or configuration setup file (or Code file) can be opened using ***Load Setup (Load Code / Password File)*** option from ***File*** menu or can also be opened using command line combined with the executable file name. Following command line switches are available

- prj Project file name** (Open Project file)
- sf Setup_file_name** (Open Setup file)
- cf Code_file_name** (Open Code file)
- nf IEEE/SN_file_name** (Open IEEE addresses / Serial number list file)
- rf Script_file_name** (Run programming sequence from the Script File)
- lock**

Note: When the **-cf** option is used, then code file name saved in the setup file (configuration file) is ignored and code file name specified with key **-cf** is used.
When the **-prj** option is used, then the **-sf**, **-cf**, **-rf** options are ignored.

Using Windows **START** button (left bottom) select **Run..** Using **Browse..** find and select executable file (see Figure 12.3-1)

"C:\Program Files\Elprotronic\USB GangPro-CC\GangPro-CC.exe"

and at the end enter the required key with name of the setup file eg.

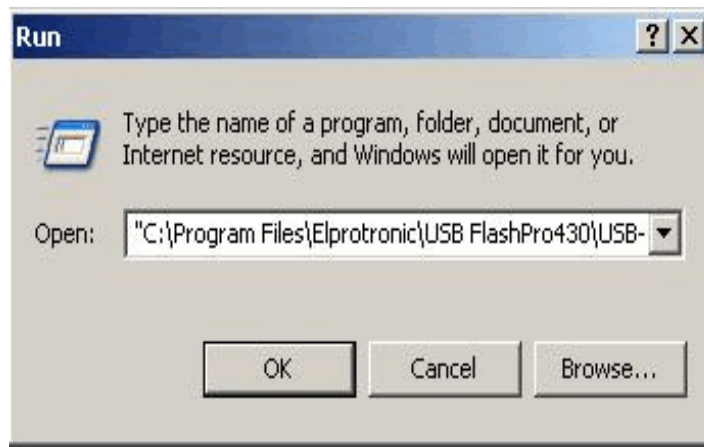

Figure 12.3-1

"C:\Program Files\Elprotronic\USB GangPro-CC\GangPro-CC.exe" -sf E:\ElproTronic\MFG\prg-04.cfg

To fully lock the configuration setup the extra key "-lock" can be added in the command line eg.

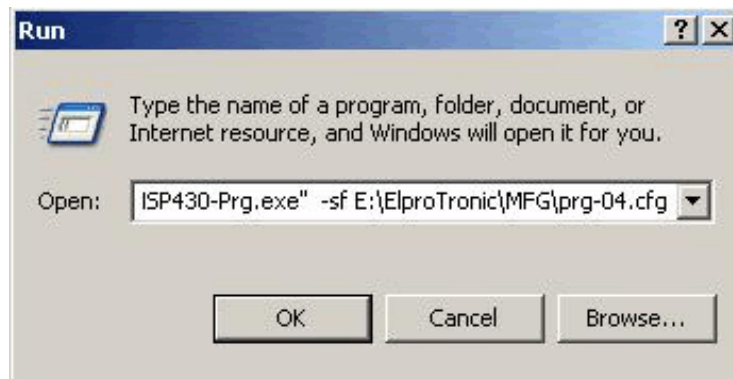

Figure 12.3-2

“C:\Program Files\Elprotronic\USB GangPro-CC\GangPro-CC.exe” -lock -sf E:\ElproTronic\MFG\prg-04.cfg
or

“C:\Program Files\Elprotronic\USB GangPro-CC\GangPro-CC.exe” -sf E:\ElproTronic\MFG\prg-04.cfg

Following configuration setup can be created using *Shortcut* options that allows to create a lot of icons located on the desktop - each icon with required independent configuration setup. To do that move the cursor to inactive desktop area, click right mouse button and select *New* (see Figure 12.3-3)

Using Browse.. in the Create Shortcut dialogue box select the following executable file

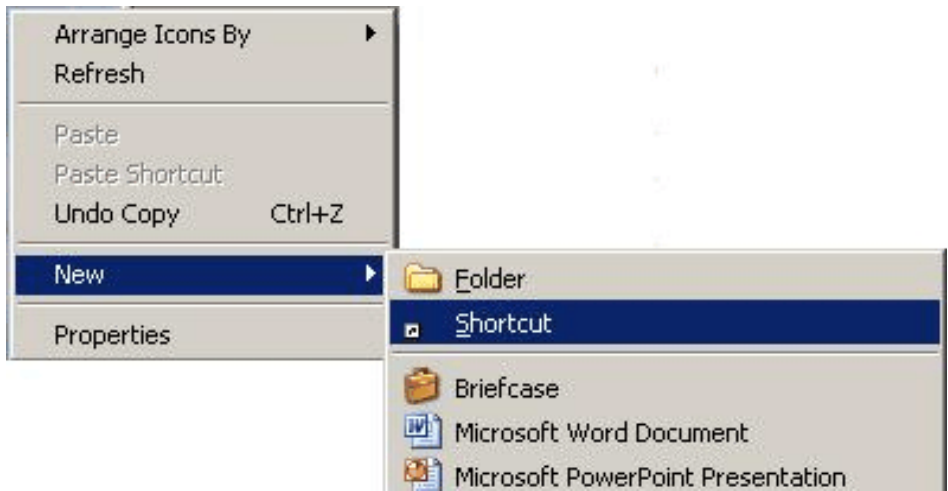

Figure 12.3-3

“C:\Program Files\Elprotronic\USB GangPro-CC\GangPro-CC.exe”

(see Figure 12.3-4) and at the and add the required command keys (see Figure 12.3-5) eg.

“C:\Program Files\Elprotronic\USB GangPro-CC\GangPro-CC.exe” -lock -sf E:\ElproTronic\MFG\prg-04.cfg

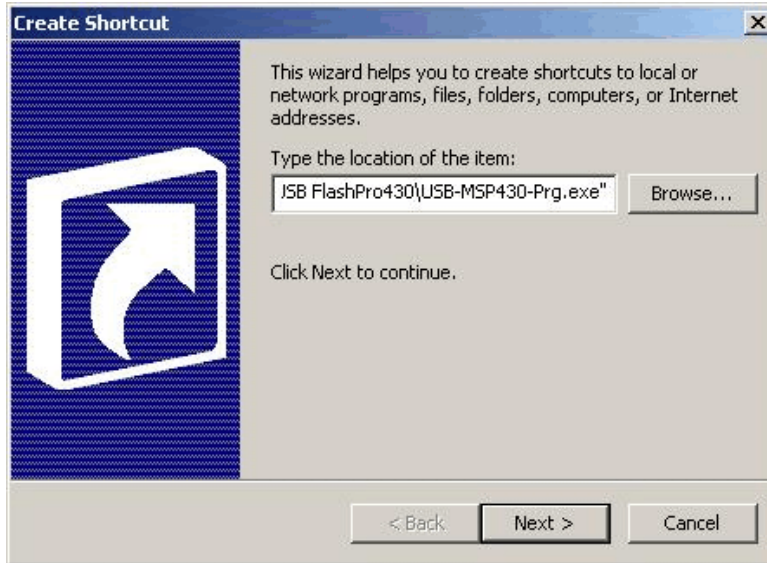

Figure 12.4



Figure 12.5

Click button *Next* and follow instruction to create icon. Using *Copy* and *Paste* and modify required configuration file names a lot of icons can be created with independent configuration setups. Clicking on the selected icon GangPro-CC programming software will start with the selected configuration setup, and locked if required.

13. Target connection

13.1 Connection via Debug Interface

Texas Instruments' boards uses 10 pins connector for communication with the CCxxxx devices, that allows to program target device via "SoC debug" interface. This connector contains all signals necessary to debug, program and interface the supported devices. In the table 13.1 and Figure 13.1 are listed and shown all pins used for debug mode. Not specified pins in this table are used for other communication and should not be grounded, shorted etc.

Table 13.1 Target's Device connector

Pin #	Name	Description
1	GND	Ground
2	Vdd / Sense	Vdd used to set correct voltage for the voltage level connector and can be used to supply target device.
3	DC	Debug Clock
4	DD	Debug Data
5	do not use	do not use
6	do not use	do not use
7	RST	RESET - Active LOW
8	do not use	do not use
9	Vdd / alt NC	Deliver Vdd from external source (OPTIONAL)

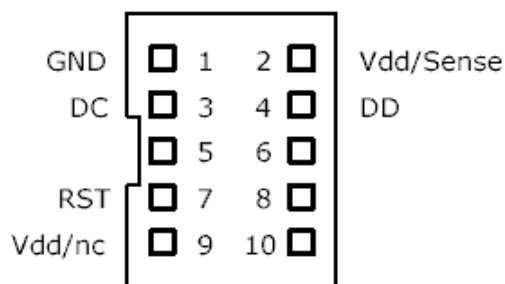

Header - Top View
Figure 13.1

The *GangPro-CC* Flash Programmers use the 14-pin connector's pinout (Figure 13.2 - Header - Top View) to facilitate connections with six target devices. All clock signals (DC) are connected in parallel to target devices and all six bidirectional data lines (DD) are connected to each target devices. Reminding lines (RST, Vdd, GND)

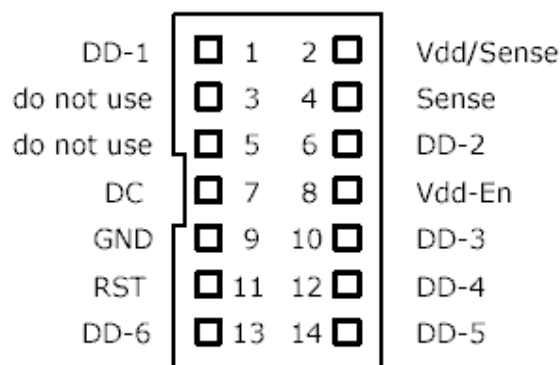

Header - Top View
Figure 13.2

are connected to all target devices in parallel. In the table 13.2 are listed all pins in the GangPro-CC adapter (USB-FPA-5.x)

Table 13.2 GangPro-CC Interface connector

Pin #	Name	Description
1 (Red)	DD-1	Debug Data output / Input - 1
2	Vdd / Sense	Vdd supplied to the target (2.2 to 3.6V/ max 100 mA) and the target's Vdd voltage sense. This pin should be connected to target's device Vdd if device is supplied from the Flash Programming Adapter. If the target's device is supplied from his own battery or from external power supply then the pin 2 or 4 (Vdd sense) should be connected to device's Vdd.
3	Busy	BUSY - 1 when the communication with target is active.
4	Sense	Target's Device Vdd Sense (see pin-2 description)
5	do not use	do not use
6	DD-2	Debug Data output / Input - 2.
7	DC	Debug Clock - common clock to all target devices
8	Vdd-En	Used to control external power supply. Voltage 2 to 5V -> Power Supply ON
9	GND	Ground
10	DD-3	Debug Data output / Input - 3.
11	\RST	Reset output
12	DD-4	Debug Data output / Input - 4.
13	DD-6	Debug Data output / Input - 6.
14	DD-5	Debug Data output / Input - 5.

Figure13-3 shows interconnection between GangPro-CC programming adapter, GangPro-CC Splitter and six target devices using debug interface.

Figure13-4 and 13-5 shows picture and schematic of the GangPro-CC Splitter.

Figure13-6 shows simplified schematic of the 14-pins Input/Output connection inside the GangPro-CC Flash Programming Adapter.

For the connection between programmed target device and programming adapter or Gang Splitter are used ribbon flat cables. Active signals DD (Data) and DC (Clock) are using pins 3 and 4 in the 10-pins connector, or wires no 3 and 4 in the flat ribbon cable. When these cable are long, then signals between these wires can be coupled and communication can be degraded. When the long cables are between GangSplitter and target devices - over 8 inches (over 20 cm) then it is recommended twist the wires 2,3 that allows to insert the Vdd wire between signal lines. This

modification will significantly reduce coupling between signal wires and allows to increase the cable length (see Figure 13.7). Communication degradation can also be reduced when the small capacitor

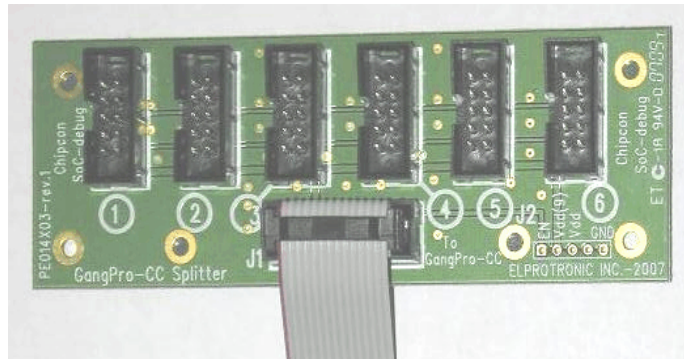

Figure 13.4

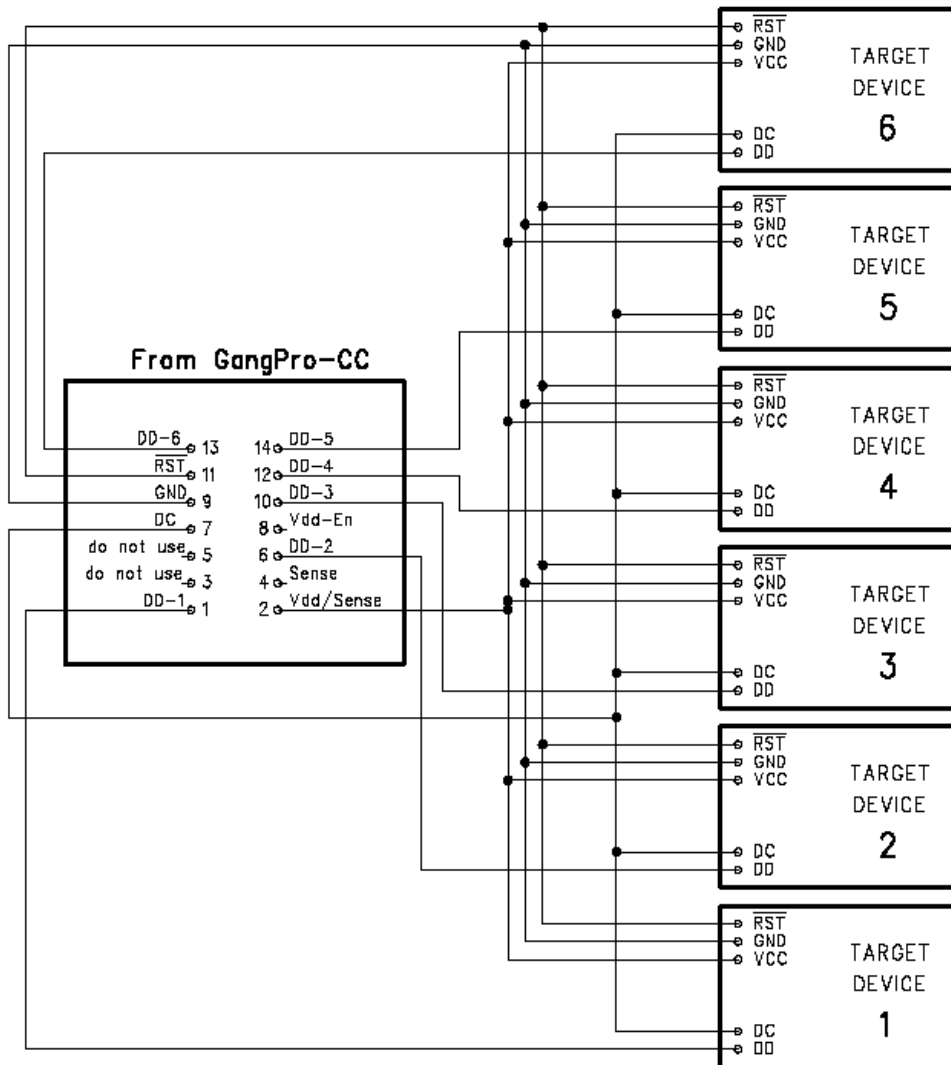

Figure 13.3

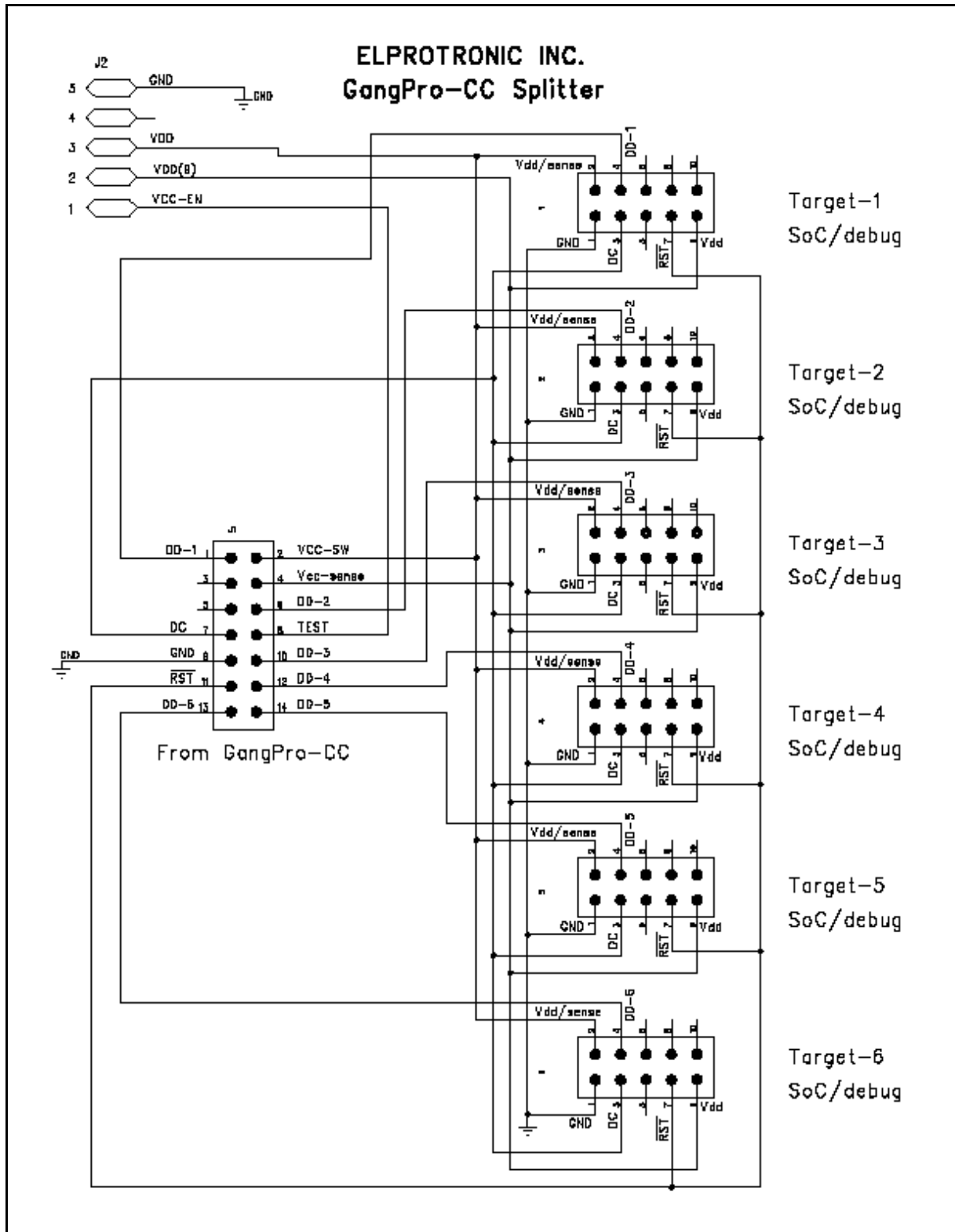

Figure 13.5

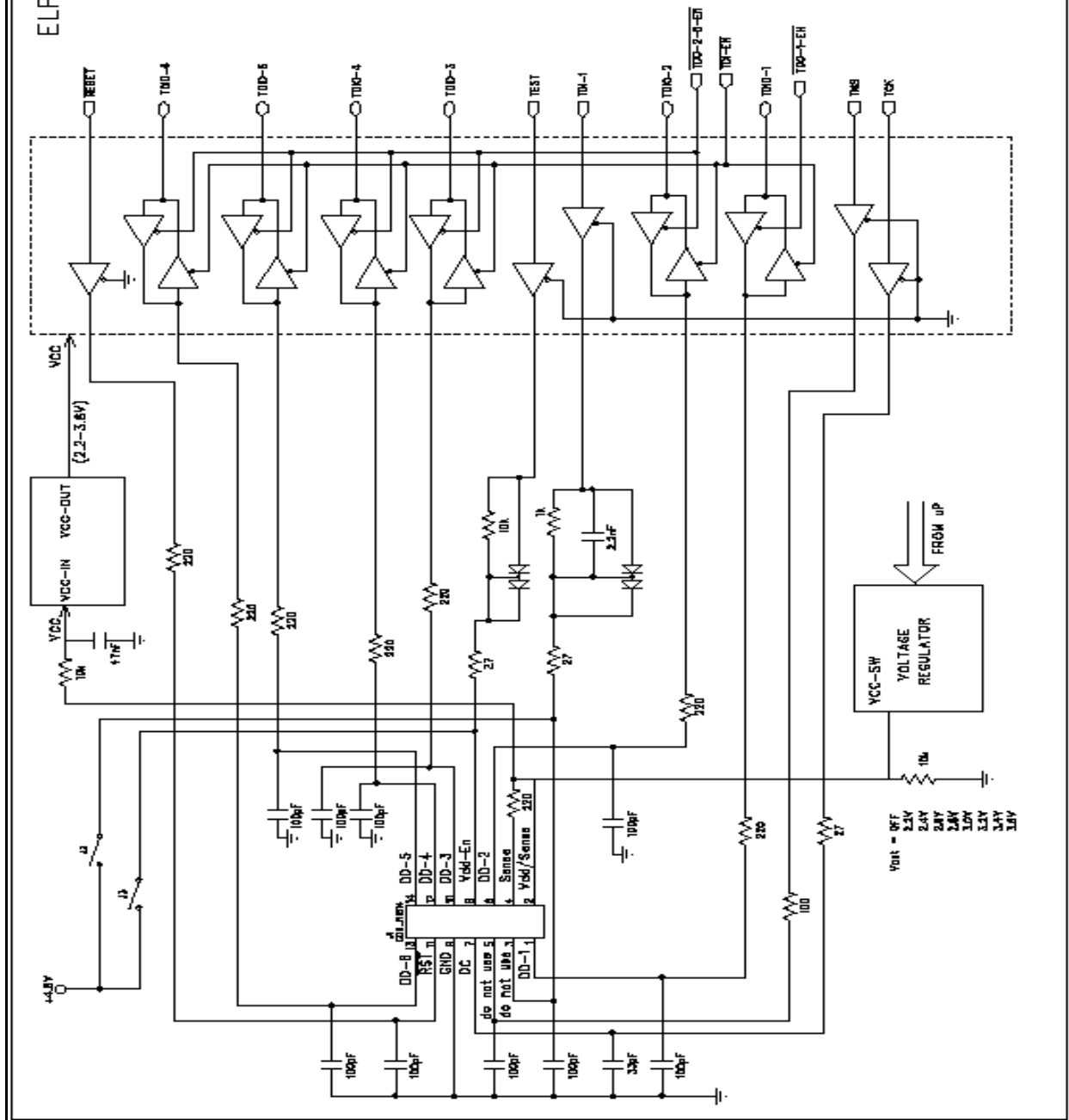

Figure 13.6

value 33 to 47 pF is connected between DD (Data) pin and ground on the target's device. Do not connect any components to the DC (Clock) pin.

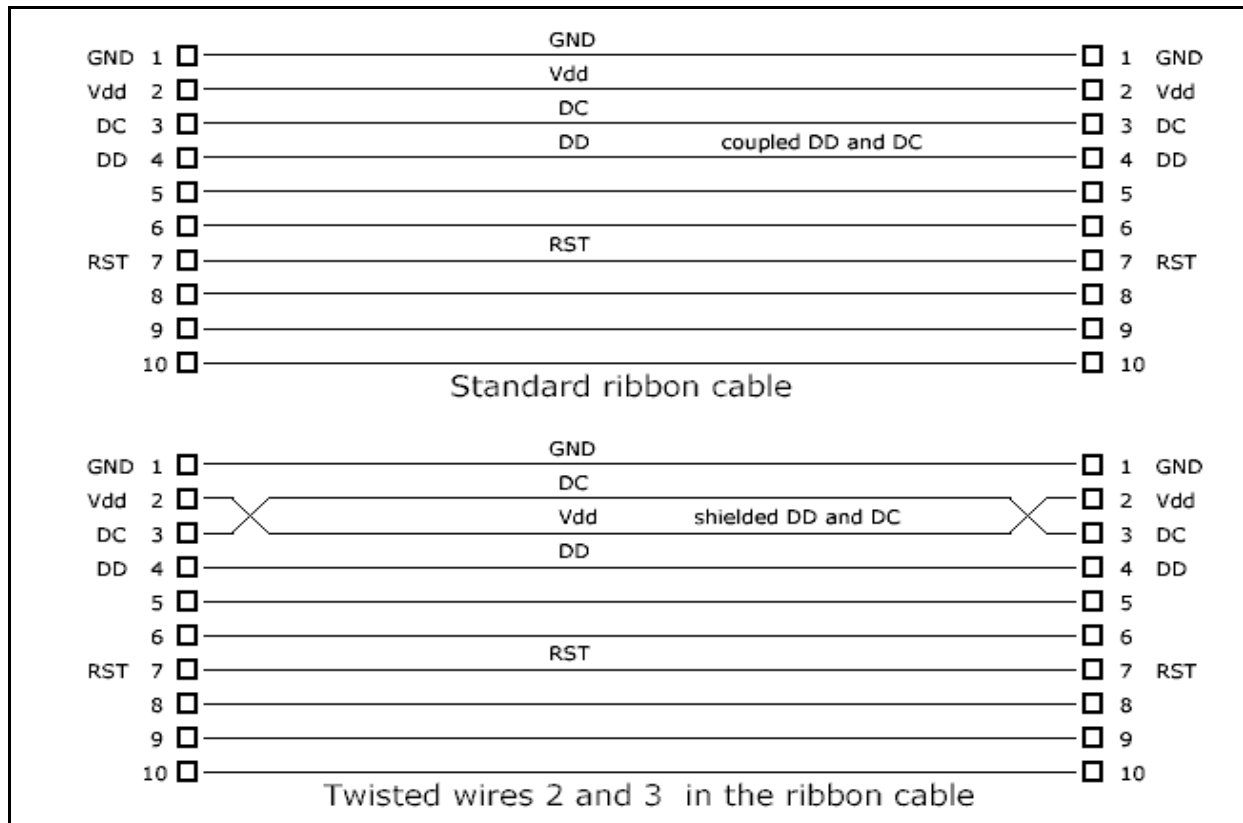

Figure 13.7

13.2 Connection via SPI Interface

Some of the latest MCU - the CC85xx (CC8520, CC8521, CC8530, CC8531) - provide only SPI communication interface for programming the MCU. The GangPro-CC provide also ability to program these devices via SPI interface, however desired adapters/gang splitters are not provided for the SPI interface. Below is the description how to connect the GangPro430 adapter with target devices and provide communication via SPI. There is a limitation, that the data downloaded to target devices must be same for all target. That means, the unique data like unique serial number cannot be downloaded to each targets. If the unique data are required then the FlashPro-CC should be used. In the Table 13-3 re provided signal description used for SPI connection with target devices .

Table 13.3 GangPro-CC connection with SPI interface

Pin #	Name	Description
1 (Red)	DD-1	MISO-1 (SPI-1 output) from the 1-st target device
2	Vdd / Sense	Vdd supplied to the target (2.2 to 3.6V/ max 100 mA) and the target's Vdd voltage sense. This pin should be connected to target's device Vdd if device is supplied from the Flash Programming Adapter. If the target's device is supplied from his own battery or from external power supply then the pin 2 or 4 (Vdd sense) should be connected to device's Vdd.
3	TDI	MOSI (SPI Input) - common SPI input to all target devices.
4	Sense	Target's Device Vdd Sense (see pin-2 description)
5	TMS	CSn - Chip enable (active LOW) - common to all target devices.
6	DD-2	MISO-2 (SPI-2 output) from the 2-nd target device
7	DC	SPI Clock - common clock to all target devices
8	Vdd-En	Used to control external power supply. Voltage 2 to 5V -> Power Supply ON
9	GND	Ground
10	DD-3	MISO-3 (SPI-3 output) from the 3-th target device
11	VRST	Reset output - common to all targets
12	DD-4	MISO-4 (SPI-4 output) from the 4-th target device
13	DD-6	MISO-6 (SPI-6 output) from the 6-th target device
14	DD-5	MISO-5 (SPI-5 output) from the 5-th target device.

14. Driver for the IAR C-Spy debugger

The FPA programming adapter can be used with the IAR Embedded Workbench IDE software for debugging. When the FPA Gang adapter is used, then the only one target connected to slot # 1 can be used for debugging. Adapter connection with the C-Spy debugger software can be done easy in two steps.

First step:

Open the IAR C-Spy debugger software and under pull down menu
Project-> Options..
Select Debugger

In the **Driver** field of the **Setup** page select **Third-Party Driver**. See figure 14-1 for details.

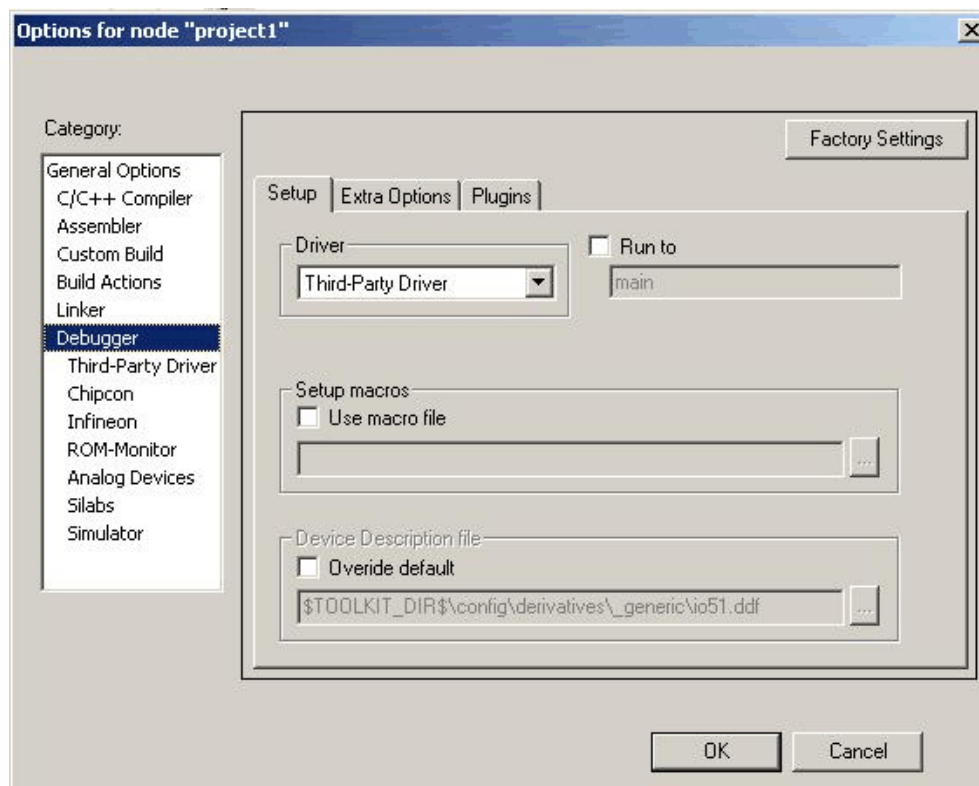

Figure 14-1

Second step:

Open the IAR C-Spy debugger software and under pull down menu
Project-> Options..
Select Debugger -> Third-Party Driver

In the **IAR debugger driver plugin field** using browse button (marked as "...") select following path for the FPA driver and select a desired driver version versus the IAR software version

C:\Program Files\Elprotronic\CCxx\Driver-for-CSpy-IAR\cc8051_fpa_7v20.dll
for the IAR EW8051 version 7.20

C:\Program Files\Elprotronic\CCxx\Driver-for-CSpy-IAR\cc8051_fpa_7v40.dll
for the IAR EW8051 version 7.40

C:\Program Files\Elprotronic\CCxx\Driver-for-CSpy-IAR\cc8051_fpa_7v50.dll
for the IAR EW8051 version 7.50

etc.

See Figure 14-2 for details

It is possible to copy and paste the dll files from the

C:\Program Files\Elprotronic\CCxx\Driver-for-CSpy-IAR

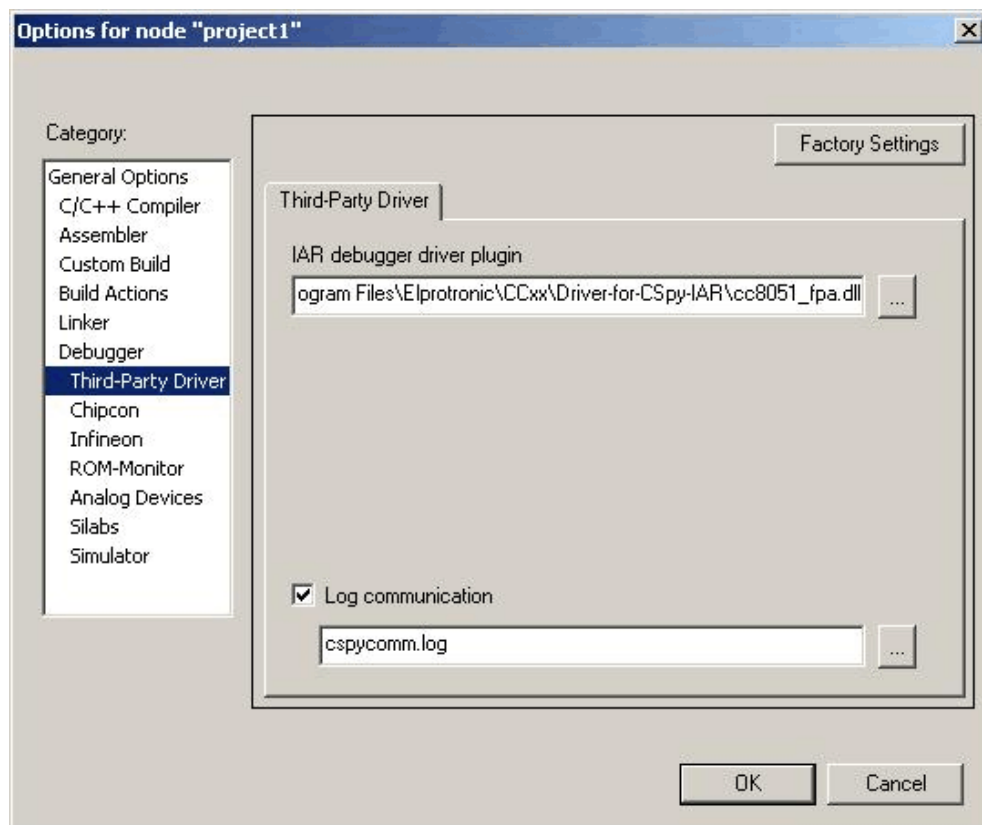

Figure 14-2

directory to other location, eg. to IAR directory

.....\8051\bin

Note, that in the

C:\Program Files\Elprotronic\CCxx\Driver-for-CSpy-IAR

directory are located two dll files - the **cc8051_fpa_xxxx.dll** that should be called directly from the IAR C-Spy debugger, and the second dll file - **ccFPAhil.dll**, that is used by the first DLL (cc8051_fpa_xxxx.dll). These two dlls should be always located in the same directory.

The IAR C-Spy debugger is ready to work with FPA adapter. Connect programming adapter to target device and try. By default - the Vcc = 3.0 volts is supplied from FPA to target device, and communication speed is fast (3Mb/s). If other setup is required, then it is possible to add extra setups in the IAR C-Spy software and modify it.

Modification can be added in the **Debugger - Extra Option** page (see figure 14-3 for details)

Currently following options are implemented (note: dash '-' must be on the front of all commands):

Command **-MCUtype**

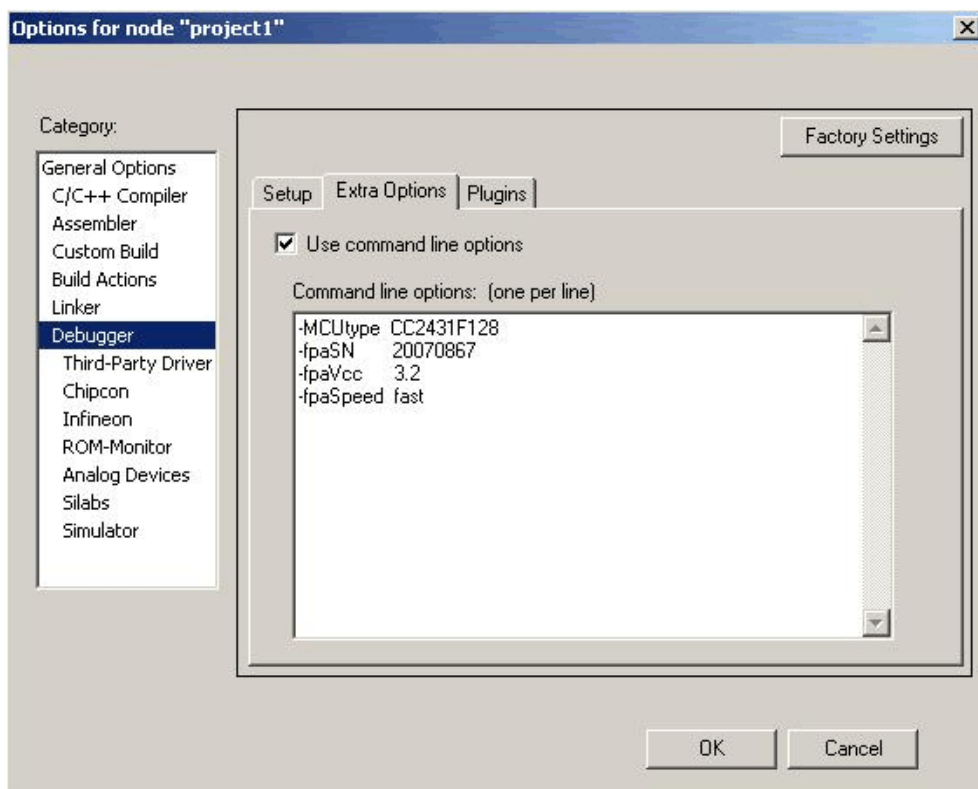

Figure 14-3

- * If commands is not used, then any CCxx can be accepted (default)
- * If MCU type is specified, then warning will be displayed, if MCU type is not the same then specified. However, if the same type of the MCU is used with different flash size then warning will not be displayed, because ID number taken from the MCU specified only MCU type, not the MCU flash size.

Acceptable MCU type list:

CC1110F8
CC1110F16
CC1110F32
CC2430F32
CC2430F64
CC2430F128
CC2431F32
CC2431F64
CC2431F128
CC2510F8
CC2510F16
CC2510F32
CC2511F8
CC2511F16
CC2511F32
CC1111F8
CC1111F16
CC1111F32
RC11xx-8kB
RC11xx-16kB
RC11xx-32kB
RC2300
CC2530F32
CC2530F64
CC2530F128
CC2530F256

Command example **-MCUtype CC2430F128**

Command **-fpaVcc**

By default, the Vcc from programming adapter is used with value Vcc= 3.0V. Vcc voltage can be modified from external of from FPA Vcc=2.2V to 3.6 V step 0.2 V

keys	0.0	(external Vcc is used - Vcc from FPA is disabled)
	2.2	(Vcc = 2.2 V from FPA is used)
	2.4	(Vcc = 2.4 V from FPA is used)
	2.6	(Vcc = 2.6 V from FPA is used)
	2.8	(Vcc = 2.8 V from FPA is used)
	3.0	(Vcc = 3.0 V from FPA is used)
	3.2	(Vcc = 3.2 V from FPA is used)
	3.4	(Vcc = 3.4 V from FPA is used)
	3.6	(Vcc = 3.6 V from FPA is used)

Note: keys 0.0 — 3.6 uses double number. All data 1.0 and below are converted to 0.0. All data over 1.0 and below 2.3 are converted to 2.2 etc.

Command example **-fpaVcc 3.2**

Command **-fpaSpeed**

By default, the fast communication speed (up to 3 Mb/s) is used. When communication is too fast (see communication speed in FlashPro-CC for details) then slower communication speed can be used - up to 1 Mb/s

Acceptable keys

fast	(speed up to 3 Mb/s)
slow	(speed up to 1 Mb/s)

Command example **-fpaSpeed slow**

Command **-fpaSN**

By default, the first detected FPA for the FlashPro-CC/GangPro-CC is used for debugging. If more than one adapter is connected to PC, then the serial number of the desired FPA (8 characters taken from the FPA label) for the IAR C-Spy debugger should be specified to avoid a problems (when other than expected FPA would be used with IAR C-Spy debugger)

When SN is specified, then only selected FPA with specified SN will be used. If adapter is not detected, and even other adapters will be available, then communication will be ignored. Option with specified SN also can be used when multi MCU for debugging are used. Each IAR C-Spy debugger should call his own FPA serial number. This allows to open more than one IAR C-Spy debugger and debug more than one MCU at the same time. One IAR C-Spy debugger will use FPA SN1, and second one - the FPA SN2.

Command example **-fpaSN 20070867**

The IEEE Address saved in the FLASH memory can be retained or defined by user and does not need to be specified in the application code. Following commands can be used for IEEE address contents in Flash manipulation

Command **-IeeeAddrLocation**

The IEEE address location (in hex) can be specified by the command **-IeeeAddrLocation**. The full IEEE address must be located in one flash sector. Make sure that 64 bits (8 bytes) address will not be located in more than one flash sector space.

Command example **-IeeeAddrLocation 0x1FFF8**

Command **-RetainIeeeAddr**

The IEEE address located in the flash at the address defined in commands **-IeeeAddrLocation** can be read before flash erase and saved together with the downloaded code when the Retain IEEE Address is enabled. Retain the IEEE Address is enabled when the command **RetainIeeeAddress** is defined

Command example **-RetainIeeeAddr**

Command **-IeeeAddrValue**

The 64 bits (8 bytes) IEEE address contents in the flash at the address defined in commands **-IeeeAddrLocation** can be defined using **-IeeeAddrValue** commands. The **RetainIeeeAddr** must be disabled, this means - the **-RetainIeeeAddr** cannot be specified.

Command example **-IeeeAddrValue 0x1234567890ABCDEF**

15. Driver for the Keil uVision debugger

The FPA programming adapter can be used with the KEIL uVision software for debugging. When the FPA Gang adapter is used, then the only one target connected to slot # 1 can be used for debugging.

FPA- adapter setup with Keil software (Uv2 or Uv3 version)

Step 1:

Copy and paste following dll files

ccFPAhil.dll

ccfpaUv2.dll

to location

C:\Keil\C51\BIN

Step 2:

Open file

TOOLS.ini located in directory

C:\Keil

and add one line

TDRVx=BIN\CCfpaUv2.dll("Elprotronic FPA for Chipcon")

where x - consecutive number of the TDRVx - inexample below - x = 4

TDRV4=BIN\CCfpaUv2.dll("Elprotronic FPA for Chipcon")

See example below - when added this line - save the file

[C51]

BOOK0=HLP\RELEASE_NOTES.HTM("Release Notes")

BOOK1=HLP\GS51.PDF("uVision2 Getting Started")

BOOK2=HLP\C51.PDF("C51 User's Guide")

BOOK3=HLP\C51LIB.CHM("C51 Library Functions",C)

BOOK4=HLP\A51.PDF("Assembler/Utilities")

BOOK5=HLP\TR51.CHM("RTX51 Tiny User's Guide")

BOOK6=HLP\DBG51.CHM("uVision2 Debug Commands")

BOOK7=HLP\ISD51.CHM("ISD51 In System Debugger")

BOOK8=HLP\FlashMon51.CHM("Flash Monitor")

BOOK9=MON390\MON390.HTM("MON390: Dallas Contiguous Mode Monitor")

TDRV0=BIN\MON51.DLL ("Keil Monitor-51 Driver")

TDRV1=BIN\ISD51.DLL ("Keil ISD51 In-System Debugger")

TDRV2=BIN\MON390.DLL ("MON390: Dallas Contiguous Mode")

TDRV3=BIN\LPC2EMP.DLL ("LPC900 EPM Emulator/Programmer")
TDRV4=BIN\CCfpaUv2.dll("Elprotronic FPA for Chipcon")
RTOS1=RTXTINY.DLL ("RTX-51 Tiny")
RTOS2=RTX51.DLL ("RTX-51 Full")
Version=V7.0
PATH="C:\Keil\C51"
SN=MSC1210

Step 3:

Run Keil software

Open Project-> Option for Target -> Debug
and select Elprotronic FPA for Chipcon

Make sure to select "*" Use.

v - Load Application at Start-up add Go To main (optional)

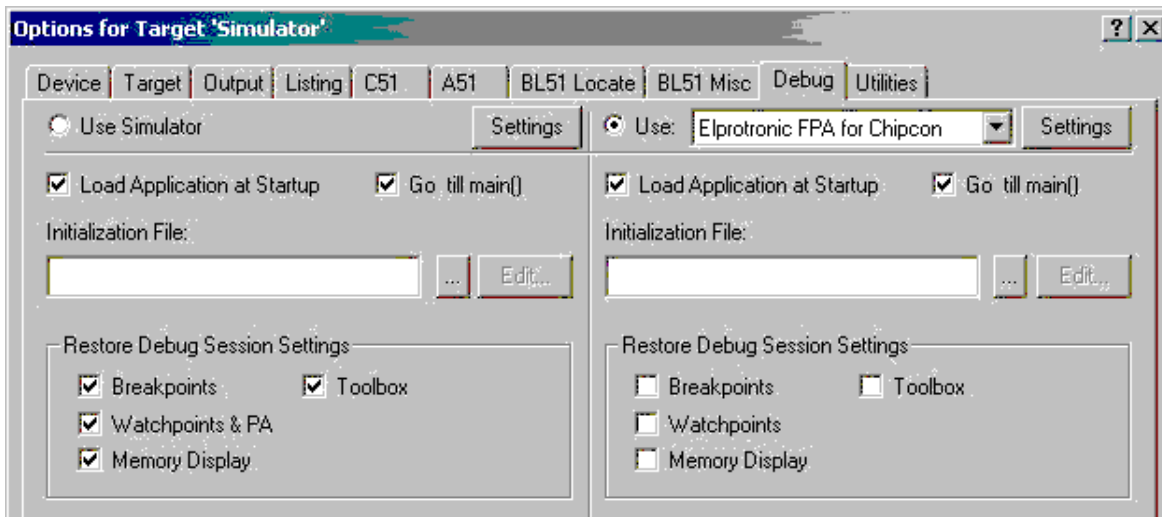

Figure 15.1

Step 4

Press Setting button and in the FPA and Target Setup select desired Vcc, communication speed and Any FPA (or selected FPA with desired FPA's Serial Number (SN) if more then one FPA is used)

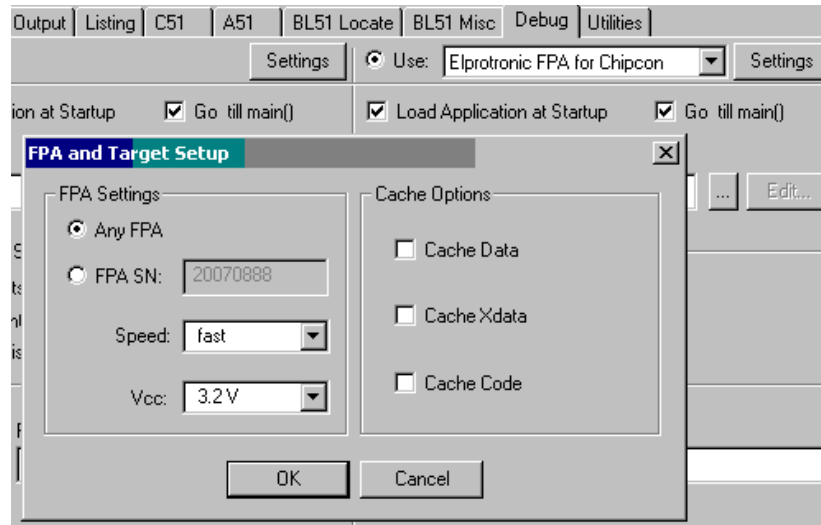

Figure 15.2

Unit is ready to work.

Appendix A - specification

Specification:

PC Communication Interface:	- Full Speed USB-1.1 (12Mbits/s)
USB connector	- Adapter site: USB-type B, Computer site: USB-type A
Target connector	- 14 pins header connector.
Number of programmed target devices	- up to 6 programmed simultaneously via debug interface
DC Power - from USB Interface	- 5V +/- 20%, 50mA + target's current (0-100mA)
Target Device DC supply	
- external	- 2.2 V to 3.6 V
- from programming adapter	- 2.2 V to 3.6 V in step 0.2V / 100 mA max.
Communication speed via debug interface	- selectable 3Mb/s or 1Mb/s
Size:	- 76 x 43 x 20 mm (3.0 x 1.68 x 0.8 inch)
Verification Compliance:	- CE (European CISPR 22 and EN 55022). - FCC Part 15, Subpart B- Class B Unintentional Radiators for Uses in Home, Commercial and Industrial Areas.