

P2 Edge Module Breadboard (#64020)

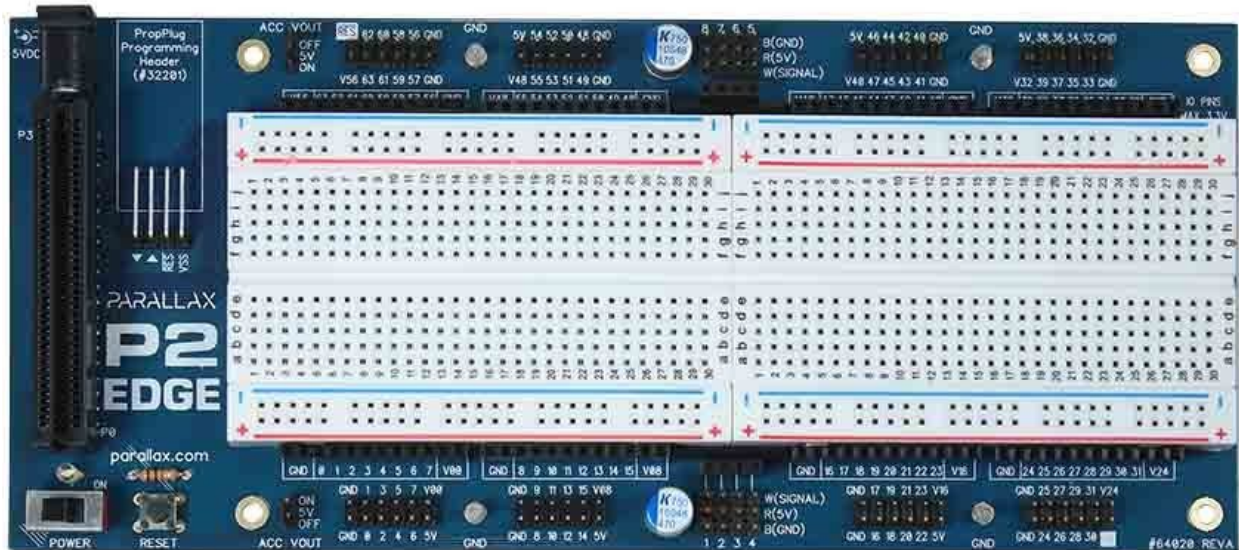

The Propeller 2 Edge Module Breadboard provides a convenient rapid prototyping solution for experimenting and developing with the Propeller 2 microcontroller.

Multiple breakout headers, ground points and a large breadboard are included for simpler testing and interfacing with standard test equipment.

The board accepts the P2 Edge Module (#P2-EC) and includes the supply voltage DC Jack socket, Parallax Prop Plug (#32201) programming socket, reset button and power switch with indicator LED.

All of the P2 Edge I/O's are available at 0.1" pin header sockets around a large breadboard. There are eight servo-style ports compatible with a range of Parallax servos and sensors, and eight P2 accessory headers, compatible with both single and dual header Propeller 2 accessories, including the mikroE Click adapter providing developers with connectivity to over 900 different Click modules for rapid development.

The P2 Edge Module Breadboard is compatible with a wide range of modules, adapters and accessories. See the Propeller 2 section of the Parallax web store at www.parallax.com for options.

Features

- Vertical socket for the Parallax P2 Edge Module (#P2-EC)
- Solder-free prototyping with breadboard and header sockets for power and I/O
- Center-positive 2.1 mm barrel jack for external 5VDC power supply
- Convenient reset button and 2-position power switch
- Power ON indicator LED
- All 64 Smart I/O pins brought out to 0.1" pin sockets and 2x6 way P2 accessory headers
- Eight 5V servo/sensor ports with series resistors for compatibility with the 3.3V P2 I/Os
- Dedicated Parallax Prop-Plug #32201 header, for system programming and debugging

Key Specifications

- Voltage input requirements: 5 VDC, absolute maximum 5.5 VDC
- Input Current requirements:
 - Recommended minimum 100 mA
 - Typical 1000 mA
 - Maximum according to customer application
- VIO Power Supplies: 3.3 V up to 300 mA per 8 I/O pins; requires P2-EC Edge Module
- Programming: Serial up to 2 MBaud; requires Parallax Prop-Plug programming adapter
- Operating temperature: -40 to +185 °F (-40 to +85 °C)
- PCB Dimensions: 3.5 x 8 in (88.9 x 203.2 mm)

Feature Descriptions

Read the full explanation of each labeled feature on the pages that follow this diagram.

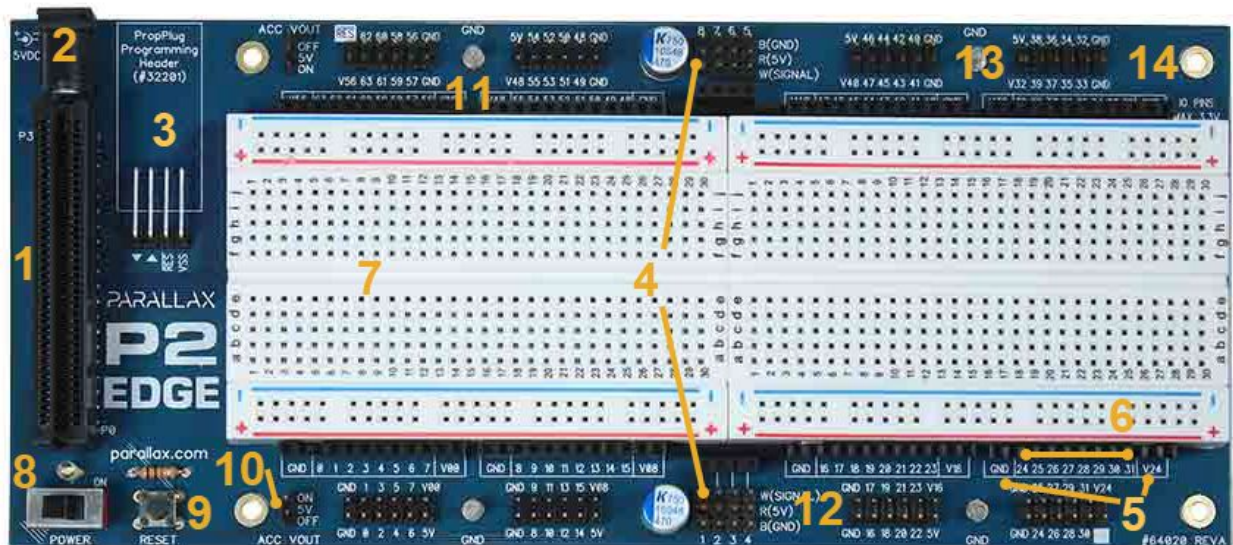

1. Parallax P2 Edge Module Socket

The P2 Edge Module socket is a 0.05" (1.27 mm) pitch 80-way vertical socket. Refer to the Edge Connector Pin Assignment in the P2 Edge Module product guide for full details. It is available for download from the P2-EC product page at www.parallax.com.

The P2 Edge Module must be inserted with the component side facing the breadboard. There are silk-screen text markings beside the socket to indicate the positions of P0 and P38.



CAUTION! The P2 Edge Module power input pads have reverse polarity protection, but damage could occur from user circuits attached to the IO pins incorrectly, so care should always be taken to ensure correct orientation!

2. Power Jack

The 2.1 mm center-positive DC power barrel jack socket accepts 5 VDC only.



CAUTION! Use a well-regulated power supply and do not exceed 5.5 VDC!

To provide power we recommend the Parallax USB A to DC-Jack cable (#805-00019). This will allow you to power the P2 Edge Breadboard from a computer USB port or hub.

For higher current applications, connect the same cable to the Parallax 5V 18W USB Power Adapter (#750-00001).

3. Prop Plug Programming Header

The P2 Edge Module is programmed by the Parallax Prop Plug programming tool (#32201).

There is a dedicated 4-way 0.1" programming and debugging header on this board to simplify connection of the Prop-Plug Adapter. The pins are marked ∇ \triangle RES VSS, and correspond to the pin labelling on the Prop Plug.

Connect the Prop Plug to your computer with a suitable USB cable, and then insert the Prop-Plug onto the 4way header pins with the Prop-Plug components facing upward. The upward orientation allows you to see the RX and TX activity LEDs on the Prop Plug while programming or debugging data is being transmitted.

Refer to [Programming Header Pin Assignments](#) for more information.

NOTE: Unplug the Prop Plug If you are using the P2 WX Adapter (#64007) and Parallax ESP8266 WX WiFi Module SIP (#34020S) for wireless programming.

4. Servo Headers

The servo ports connect servos and other 3-pin devices to the 0.1" pin sockets positioned alongside each port, so that the signals can be jumpered to the breadboard or directly to a P2 Edge I/O pin.

In the image example, we can see servo port 5 on the right. The pinout follows the Parallax standard BRW cable color scheme (Black-Red-White).

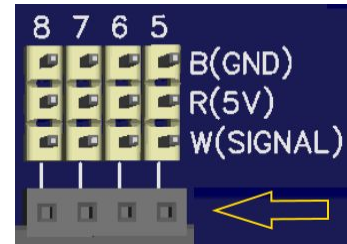

The top pin connects to Ground (Black wire). The middle pin connects to 5V, directly from the DC Barrel Jack (Red wire). The bottom pin (White) is the signal pin, and connects via an onboard 1K series resistor to the corresponding pin socket below (marked with the arrow).



CAUTION! For servos and other high-current devices, ensure a quality high current external power supply is connected to the [Power Jack](#), such as the Parallax 5V 18W USB Power Adapter (#750-00001).



CAUTION! Do not attempt to drive servos or other high-current devices from computer-USB power. This may cause unexplained behavior, and could be detrimental to some computer systems.

5. VIO 3.3V Power and GND Access

The positive 3.3 V supply sockets and ground sockets are positioned around the breadboard, and also at the 2x6 way P2 accessory headers. Use jumper wires to connect these sockets to circuits you build on the breadboard.

Each group of 8 smart I/O pins has its own 3.3 V low-noise regulator, with short-circuit and over-current protection.

You may see this voltage referred to as VIO (Voltage for IO), and is labelled beside each group of I/O pins in the format Vxx.

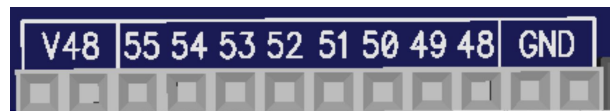

The two digits after the V refer to the first of 8 I/O pins that the LDO provides power to. For example in the image, V48 would mean VIO voltage for I/O pins 48 to 55.



CAUTION! DO NOT join the Vxx pins together. The voltage output is for logic level and low current supply only to the corresponding group of 8 I/Os (30 mA per pin,

300 mA total). If a larger current common supply is required, add an alternative power source to the breadboard, such as the Parallax Power Pal (#32133).

6. P2 Edge I/O Pin Access

Access to the P2 Edge Module smart I/O pins P0...P63. Use jumper wires to connect these I/O pins to circuits on the breadboard. In the above image, the I/O pins are labelled 48 to 55.

7. Breadboard

The breadboard area has dual 30 x 5-socket rows arranged in 2 columns, for a total of 60 rows. The columns are separated by a valley in the middle. Any two wires plugged into the same 5-socket row become electrically connected. The socket spacing is 0.1"

8. Power Switch and Power Indicator LED

The power switch has 2 settings:

- 0 — off
- 1 — on

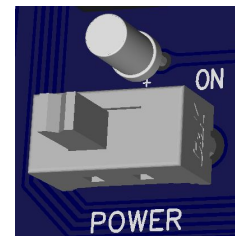

The white power indicator LED will light when the power switch is on. Not that in certain circumstances, if the power supply is disconnected while the power switch is still on, you may notice the power LED remains lit for a period of time. This is normal and expected behaviour due to the bulk capacitors included in the circuit.

9. Reset Button

Use this button to restart the Propeller 2 microcontroller's program running on the P2 Edge Module. Press and hold to keep the microcontroller in reset. Press and release to reset, load and run the program in EEPROM.

10. ACC ON/OFF Header

The 3-position 2mm pitch shunt headers allow the 5V output at the P2 accessory headers to be connected or disconnected from the DC Barrel Jack 5V supply. The 5V power supply is connected to the middle pin labeled 5V, so position the provided shunt jumper either upward or downward, connecting 5V to either the ON or OFF position as required.



11. Ground Test Posts

The four ground test posts are suitable for test clips and scope probes; two are positioned at the top and bottom of the board.

12. I/O Pin Accessory Headers (with 5V output)

Each of the 64 smart I/O pins is connected to an accessory header, in specific groups of eight.

Each edge header also provides two GND connections, a V_{xx} output pin supplying the voltage from the corresponding 3.3 V LDO voltage regulator, described above in [VIO 3.3V Power and GND Access](#), and optionally a 5 V output connection (controlled by the [ACC ON/OFF Header](#)).



There are two special usage edge header banks which do not supply the 5V output. Refer to the details here: [I/O Pin Breakout Edge Headers \(without 5V output\)](#)



CAUTION! Do not apply voltage to the V_{xx} Pin; it is a voltage output! Be aware that some I/O pins are also connected to other peripheral circuits; see the [Edge Connector Pin Assignments](#) section.

13. I/O Pin Breakout Edge Headers (without 5V output)

There are two edge headers which do not have 5V routed to them.

The header for P24 to P31 is shown with a white silk square for the pin beside the V_{xx} pin. This unlabelled pin is unconnected, but could be used for connecting a user signal or voltage to a user accessory board or prototype board.



The header for P56 to P63 has the RES pin beside the V_{56} pin. The RES pin is active low, and is connected to the Propeller 2 microcontroller RESn circuit on the P2 Edge Module. Momentarily set this pin low to reset the Propeller.

This header is ideal for connecting to the Parallax P2 WX Adapter (#64007) with the Parallax ESP8266 SIP WiFi module (#32420S) in order to program the Propeller 2 wirelessly.

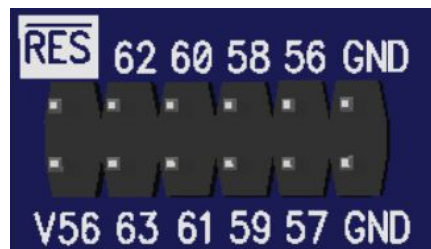

14. Mounting Holes

The four plated mounting holes are attached to the ground plane. See the [PCB Dimensions](#) section for mounting hole dimensions and spacing.

Propeller 2 Physical Pins

This illustration identifies the physical pins on the Propeller 2. See the Propeller 2 documentation section of www.parallax.com for detailed information about the device. In this document, see the [Edge Connector Pin Assignments](#) section for details on how they are used on the P2 Edge Module.

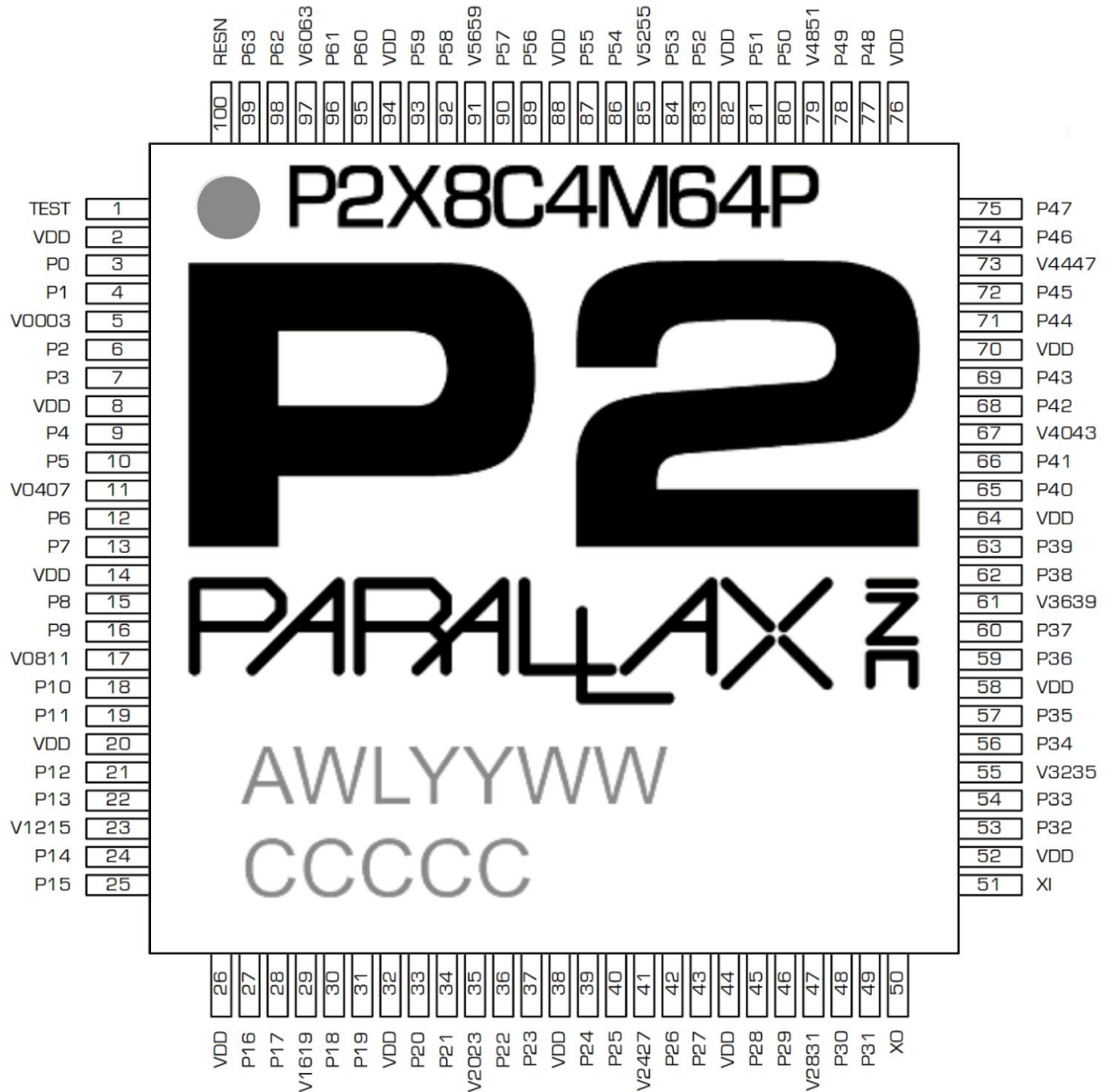

Edge Connector Pin Assignments

Smart I/O pins P0–P55 are fully free; P56–P63 are routed to peripheral circuits and/or have special functions related to Propeller 2 boot sequence options. Each smart I/O pin is capable of many autonomous analog and digital functions. Examples include ADC, DAC, PWM, USB, SERIAL, Waveform generation, SMPS, Comparator, SCHMITT and LOGIC modes.

See the Propeller 2 Documentation section of www.parallax.com for detailed information about the full capabilities of the Propeller 2 Smart I/O pins.

I/O Pin	Description
P0-P7	Smart I/O pins, 3.3 V logic level, source or sink 30 mA per I/O pin. On-board LDO regulator supplies 300 mA total, shared by this I/O pin group and edge connector pin V00.
P8-P15	Smart I/O pins, 3.3 V logic level, source or sink 30 mA per I/O pin. On-board LDO regulator supplies 300 mA total, shared by this I/O pin group and edge connector pin V08.
P16-P23	Smart I/O pins, 3.3 V logic level, source or sink 30 mA per I/O pin. On-board LDO regulator supplies 300 mA total, shared by this I/O pin group and edge connector pin V16.
P24-P31	Smart I/O pins, 3.3 V logic level, source or sink 30 mA per I/O pin. On-board LDO regulator supplies 300 mA total, shared by this I/O pin group and edge connector pin V24.
P32-P39	Smart I/O pins, 3.3 V logic level, source or sink 30 mA per I/O pin. On-board LDO regulator supplies 300 mA total, shared by this I/O pin group and edge connector pin V32.
P40-P47	Smart I/O pins, 3.3 V logic level, source or sink 30 mA per I/O pin. On-board LDO regulator supplies 300 mA total, shared by this I/O pin group and edge connector pin V40.
P48-P55	Smart I/O pins, 3.3 V logic level, source or sink 30 mA per I/O pin. On-board LDO regulator supplies 300mA total, shared by this I/O pin group and edge connector pin V48.
P56-P63	Smart I/O pins, 3.3 V logic level, source or sink 30 mA per I/O pin. On-board LDO regulator supplies 300 mA total, shared by this I/O pin group and edge connector pin V56.
Alternative functions for P56-P63	
P56	Buffered LED
P57	Buffered LED
P58	Flash SPI DO (MISO)
P59	Flash SPI DI (MOSI)
P60	Flash SPI CLK
P61	Flash SPI CS
P62	Prop-Plug RXD (P2 TXD)
P63	Prop-Plug TXD (P2 RXD)

Other Pins	Description
RESn	Internally pulled up to 3.3V with 10K resistor. Propeller chip will reset when RESn driven low; all cogs disabled and I/O pins floating. Propeller restarts 3 ms after RESn transitions from low to high.
5V	Power input pins for the Edge Module. Connect both 5V edge connector pads to a good quality 5VDC supply. The supply voltage MUST NOT exceed 5.5V! Recommended minimum supply current 100mA, up to 3A depending on customer code and circuit. Factors contributing to current requirements include operating frequency, number of operating cogs, smart pin instruction types and external I/O circuitry.
GND	Provides common signal and supply voltage ground. Connection of all edge connector GND pads to a solid ground plane on an external layer recommended.
NC	Not Connected. Reserved for future use. Recommended "Do Not Connect" in customer designs.

Programming Header Pin Assignments

The P2 Edge Module Breadboard uses the following markings for the programming header pins located near the top left of the breadboard : ▽ △ RESn GND

The arrows point inward (toward) the pad for RX and outward (away from) the pad for TX.

When using a serial programming device, such as Prop Plug, ensure that the Prop Plug TX pin connects to the P2 Edge RX pin, and that that Prop Plug RX pin connects to the P2 Edge TX pin.

Recommend and Absolute Maximum Ratings

Symbol	Quantity	Recommended	Maximum	Units
5 VDC	DC Barrel Jack Supply Voltage †	5	5.5	V
P0 - P63	Any I/O Pin	3.3	3.6	V
RESn	Reset input, active low	3.3	3.6	V

Programming Software

Propeller Tool is our recommended tool for programming the P2 Edge Module in SPIN and PASM languages. Other programming languages are possible using third party tools, such as C, BASIC, Forth.

You can find links to the latest tools at the Propeller 2 Software section of www.parallax.com.

Board Dimensions

Higher resolution board dimension drawings are packaged with the P2 Edge Module Breadboard schematics available for download from the 64020 product page at www.parallax.com.

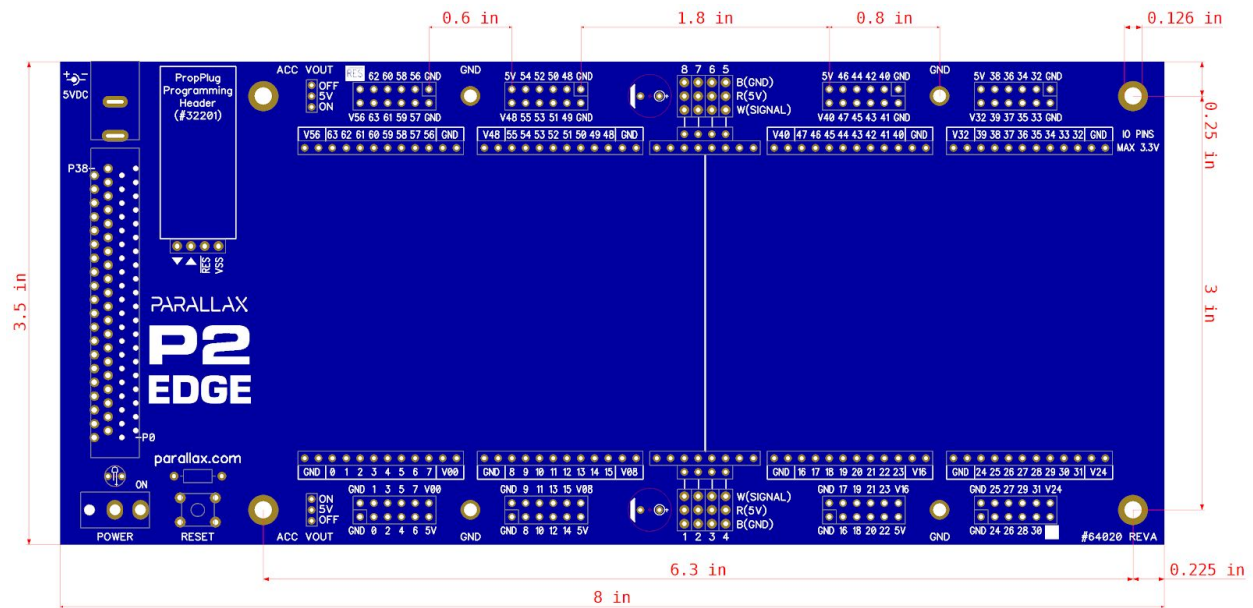
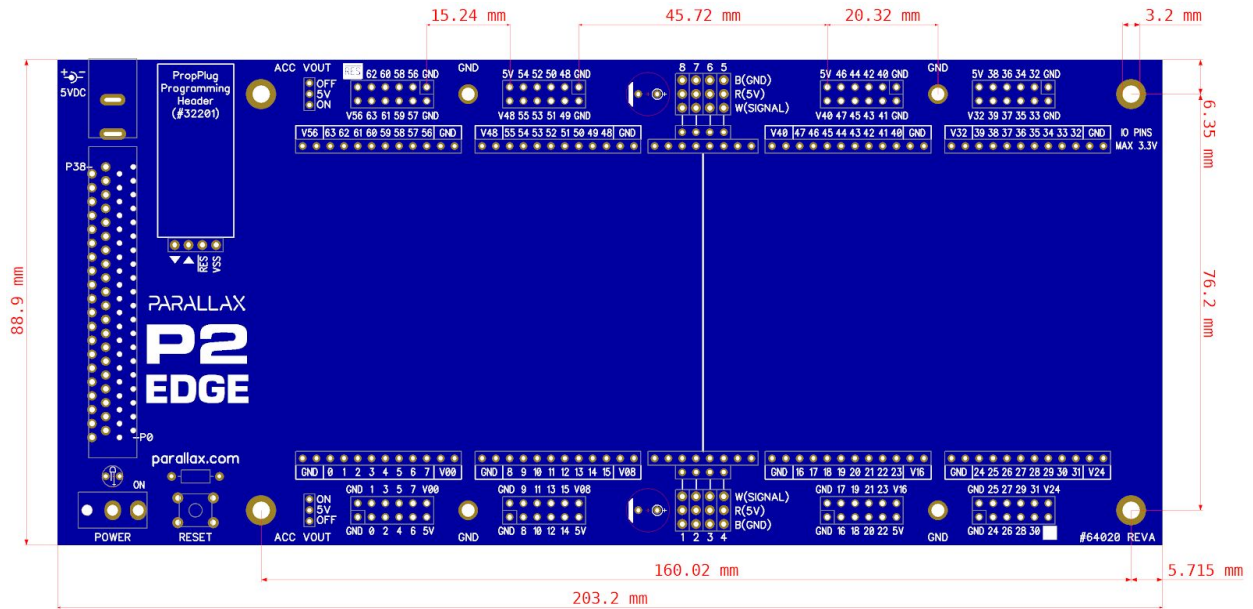

Mounting Holes Detail

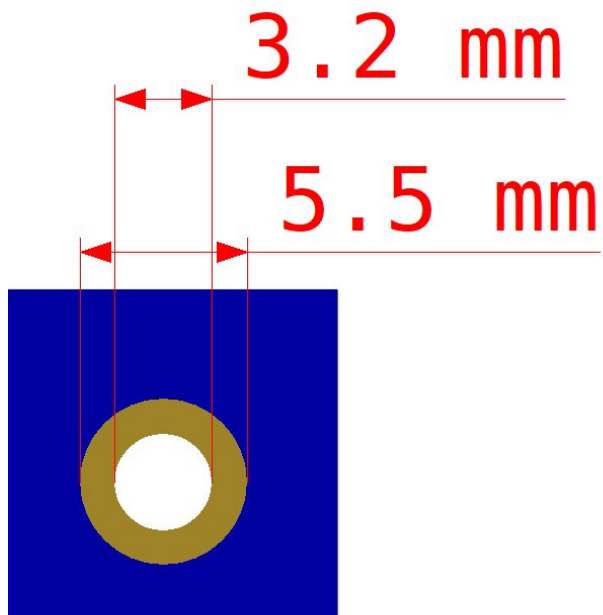

Resources and Downloads

Check for the latest version of this document, free software, and example programs from the P2 Edge Module Breadboard product page. Go to www.parallax.com and search 64020.

Revision History

Version 1.0: original production release. Version 1.1 Updates to the Prop Plug section expanded.